



Version US 3.0

Beam Hanger Design Guide

ASD Design for the United States



Disclaimer

The information in this document is provided on an “as is” basis and for general information purposes only. While MTC Solutions aims to keep the information provided in this document complete, accurate, and in line with state-of-the-art design methods, MTC Solutions, its affiliates, employees, agents, or licensors do not make any representations or warranties of any kind, including, but not limited to, express or implied warranties of fitness for a particular purpose or regarding the content or information in this document, to the full extent permitted by applicable law.

The information in this document does not constitute engineering or other professional advice, and any reliance users place on such information is therefore strictly at their own risk. Images and drawings provided within this document are for reference only and may not apply to all possible conditions. MTC Solutions shall not be liable for any loss or damage of any kind, including indirect, direct, incidental, punitive, or consequential loss or damage arising out of, or in connection with, the information, content, materials referenced, or the use of any of the systems described in this document. Users may derive other applications which are beyond MTC Solutions’ control. The inclusion of the systems or the implied use of this document for other applications is beyond the scope of MTC Solutions’ responsibility.

Published on March 10th, 2025. Copyright © 2025 by MTC Solutions. All rights reserved.

This document or any portion thereof may not be reproduced or used in any manner whatsoever without the expressed written permission of the publisher.



Beam Hanger Design Guide

ASD Design for the United States



Table of Contents

HOW TO USE THIS GUIDE	10
GENERAL NOTES TO THE DESIGNER.....	12
GENERAL NOTES TO THE INSTALLER.....	14
BEAM HANGER SELECTION TOOL.....	15

GIGANT.....	17
GIGANT Overview	18
GIGANT Design Information.....	19
GIGANT Series - Geometry Requirements.....	20
Additional Detailing Considerations.....	23
Housing Details.....	24
Housing Dimensions	25
GIGANT Installation Configurations.....	26
GIGANT Installation Procedure.....	27

RICON S VS.....	33
RICON S VS Overview	34
RICON S VS Design Information.....	35
RICON S VS Clip Lock.....	37
RICON S VS 60 Series - Geometry Requirements.....	38
RICON S VS 80 Series - Geometry Requirements.....	41
RICON S VS XL - Geometry Requirements	44
Additional Detailing Considerations.....	47
Skewed and Sloped Configurations	48
Housing Details.....	49
Housing Dimensions.....	50
RICON S VS Installation Configurations.....	52
RICON S VS Installation Procedure	53

MEGANT.....	59
MEGANT Overview	60
MEGANT Design Information.....	62
MEGANT 60 Series - Geometry Requirements.....	63
MEGANT 100 Series - Geometry Requirements.....	67
MEGANT 150 Series - Geometry Requirements.....	71
Additional Detailing Considerations.....	75
Housing Details.....	76
Housing Dimensions.....	77
MEGANT Installation Configurations.....	79
MEGANT Installation Procedure	80

ACCESSORIES 87

Bits 87

Bit Holder Socket 87

Predrilling Jig 88

Clip Lock Brace System for Uplift 89

APPENDIX 91

Appendix A: Fire Protection 92

Appendix B: Uplift Resistance Design 98

Appendix C: Survey of Literature on Reinforcement for Tension Perpendicular to Grain 100

Appendix D: Product Specifications 109

Mass Timber Hardware Specialists



At MTC Solutions, our core focus is to supply structural hardware for modern mass timber applications in commercial, industrial, and residential projects. Our pride lies in collaborating with leading industry experts to offer design solutions and tools for code-compliant, sustainable buildings, continuously pushing the boundaries of the North American construction industry.

Our in-house team of mass timber specialists support professionals in designing customized connections that cater to the specific requirements of each project, resulting in truly innovative and cost-efficient solutions. With industry-recognized expertise and tested & proven solutions, we stand at the forefront of the industry, driving progress and innovation in mass timber construction.



Expertise

We provide our customers with the knowledge and tools necessary to construct cutting-edge, code-compliant mass timber projects while pushing the boundaries of the North American construction industry.



Commitment

We are dedicated to making your project a success, offering support from design and installation assistance to fast and precise delivery of high-quality products.



Products Tailored for North America

We partner with leading research facilities across North America to ensure that our products are tested and customized to meet the unique needs of the market, including seismic considerations and solutions for large post-and-beam structures in various climates.

Find Your Connection Solution

MTC Solutions provides the right tools to design code-compliant buildings, educating the mass timber industry on connection solutions.

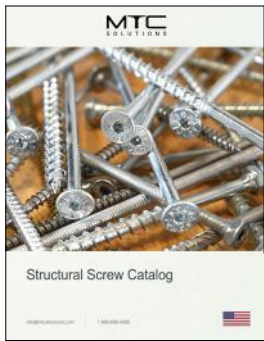

Structural Screw Catalog



Structural Screw Connection Design Guide



Structural Fasteners



Accessories

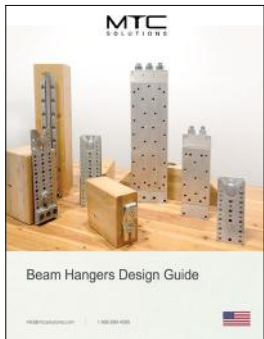

Beam Hangers Design Guide



Beam Hangers



Connector Design Guide



Connectors



Rigging Design Guide



Rigging Devices



Fall Arrest Anchor Design Guide



Fall Arrest



**WHO
ARE WE?**

YOUR MASS TIMBER HARDWARE SUPPLIER

Rely on our distribution team to deliver your North American projects with speed and accuracy.

LEADING WITH INNOVATION & RESEARCH

We are leading the mass timber industry with cutting-edge connection solutions and through partnerships with renowned research facilities.

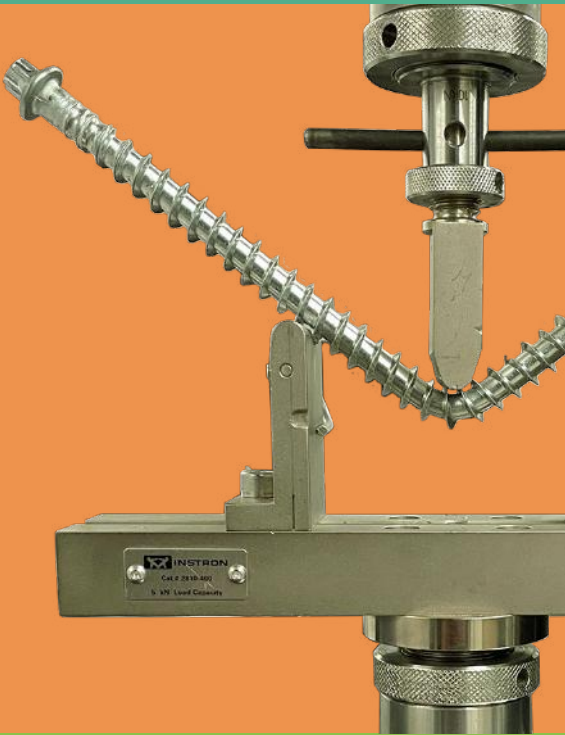

WE MAKE YOU THE EXPERT

Learn about the right solutions for your projects and mass timber connections with our technical resources & support team!

CONNECTION DESIGN SUPPORT

Reach out to our technical team for design support, from early design stages to ongoing iterative changes. We help you find the most efficient connection solutions.



MANUFACTURERS' HELP DESK

Use our comprehensive & practical resources to find the most cost-effective solutions for your structural elements.



TESTED & PROVEN SOLUTIONS

Count on MTC Solutions' 10+ years of expertise, providing tested & proven, ICC-approved solutions, support, and resources.



How to Use This Guide

RICON S VS

Pre-Engineered Connection System

The RICON S VS connector is an ICC-Approved, pre-engineered, beam-to-column or beam-to-beam connector manufactured from mild steel with a welded collar bolt. It consists of two identical parts and is suitable for use in all timber and hybrid-timber construction applications. The RICON S VS connector has been extensively tested for the North American Market.



Pre-Installable

Pre-Installable in a controlled shop environment for a faster on-site installation.

Fire-Resistance-Rated

Fire-Resistance rating up to 2 hours per ICC ESR-2024.

Design

- Wood-to-Wood Design Values
- Wood-to-Steel Design Values

Intersory Drift Performance-Tested

Drift ratio exceeding 4% in non-cyclic residual loading.

Hybrid Construction Compatible

Can be installed in wood-to-wood or wood-to-steel beam or end-rod plate.

Detailing

- General Detailing Information
- Detailing RICON S VS 80 Series
- Detailing RICON S VS 120 Series
- Detailing RICON S VS XL Series
- Additional Design/Placement Considerations

Fully Concealable

Easy to conceal connections, enhancing architectural wood features.

Design Installation

A fast, straightforward, & repeatable installation process that significantly enhances efficiency.

Installation

- Installation Considerations
- Routing Information
- Seal Requirements

Overview

This section provides the key highlights for each product, including product description, key design features, and product certifications.

This sidebar outlines the design values, detailing information, and installation guidelines included in each product subsection.

RICON S VS Overview

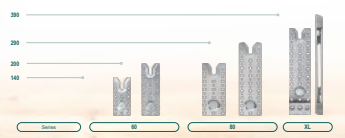

Table 2.1 - RICON S VS Hardware Package Installation Overview

RICON S VS Model	Type	Fasteners		Installation Time (min)
		Primary Member	Secondary Member	
RICON S VS 80 140 x 80	S	VS CSM 3" x 3/8"	VS CSM 3" x 3/8"	12
		VS CSM 3" x 3/8"	VS CSM 3" x 3/8"	12
RICON S VS 80 200 x 80	S	VS CSM 3" x 3/8"	VS CSM 3" x 3/8"	12
		VS CSM 3" x 3/8"	VS CSM 3" x 3/8"	12
RICON S VS 80 200 x 140	S	VS CSM 3" x 3/8"	VS CSM 3" x 3/8"	12
		VS CSM 3" x 3/8"	VS CSM 3" x 3/8"	12
RICON S VS 120 140 x 80	S	VS CSM 3" x 3/8"	VS CSM 3" x 3/8"	12
		VS CSM 3" x 3/8"	VS CSM 3" x 3/8"	12
RICON S VS 120 200 x 80	S	VS CSM 3" x 3/8"	VS CSM 3" x 3/8"	12
		VS CSM 3" x 3/8"	VS CSM 3" x 3/8"	12
RICON S VS XL 200 x 80	S	VS CSM 3" x 3/8"	VS CSM 3" x 3/8"	12
		VS CSM 3" x 3/8"	VS CSM 3" x 3/8"	12

RICON S VS Seismic Performance

MTC has conducted extensive quasi-static, in-timber and component testing on the RICON S VS connector. The results have demonstrated its robust performance under both axial and drift demands.

- The RICON S VS connector is capable of resisting axial forces in excess of 50% of its download capacity while fully loaded in accordance with ASCE 7-22 Sections 1.4.3 and 12.1.4.
- The RICON S VS can accommodate drift of over 4% while fully loaded, which satisfies the drift limits specified in ASCE 7-22 Table 12.2-1.

Contact MTC Technical Support for additional details for accommodating seismic loads in your design.

This table provides an overview of the hardware package required for a beam hanger connection, including the number of plates, fasteners for both primary and secondary members, and installation times.

RICON S VS Design Information

Wood-to-Wood Design Values

Table 2.2 - Allowable Loads for RICON S VS for Wood-to-Wood Connections

RICON S VS Model	Configuration	Minimum Secondary Beam Section Dimensions (In.)			Allowable Loads (lb.)	
		No FRR	1-hr FRR	2-hr FRR	Download w/ Clip Lock	Uplift w/ Clip Lock
RICON S VS 140 x 80	Single	3-5/8 x 7-5/16	5-25/32 x 9-1/32	8-3/8 x 11-1/16	2,542	1,870
	Double	6-5/16 x 7-5/16	8-15/32 x 9-1/32	11-1/16 x 11-1/16	2,542	1,870
RICON S VS 200 x 80	Single	3-5/8 x 9-1/16	5-25/32 x 11-23/32	8-3/8 x 13-7/16	2,542	1,870
	Double	6-5/16 x 9-1/16	8-15/32 x 11-23/32	11-1/16 x 13-7/16	2,542	1,870
RICON S VS 200 x 140	Single	4-23/32 x 15-1/4	6-5/16 x 13-1/4	9-5/32 x 13-31/32	2,542	2,420
	Double	8-3/32 x 15-1/4	10-1/8 x 13-1/4	13-1/16 x 13-31/32	2,542	2,420
RICON S VS 200 x 80	Single	4-23/32 x 15-1/32	6-5/16 x 14-5/8	9-5/32 x 16-11/32	2,542	2,420
	Double	8-3/32 x 15-1/32	10-1/8 x 14-5/8	13-1/16 x 16-11/32	2,542	2,420
RICON S VS XL 200 x 80	Single	4-23/32 x 16-1/16	6-5/16 x 19-3/16	9-5/32 x 20-7/8	2,542	2,420
	Double	8-3/32 x 16-1/16	10-1/8 x 19-3/16	13-1/16 x 20-7/8	2,542	2,420

Notes:

1. Connector design must meet all relevant requirements of the General Notes to the Designer section.
2. Lateral allowable loads are applicable for wood-to-wood connections only.
3. Seismic resistance must follow the values presented in the installation section.
4. Allowable single-configuration load values for 2 x 250 are certified to ICC-ES ESR-2020 (2020). Values for 2 x 140 are EC-compliant in accordance with ASTM D7747.
5. Member dimensions for secondary beams with no FRR are based on testing done in accordance with ASTM D7747. Member dimensions for beams with FRR are based on minimum wood cover requirements specified in NDS 2024 Chapter 9.5. For beams with an FRR, three-sided exposure is assumed. Beam sizes satisfying an FRR assume a fire-resistant joint compliant with ICC-ES ESR-2024 Section 2.1.4 and are tested under full wood dry.
6. Tabulated capacity assumes members are perpendicular to beam depth that do not require reinforcement. Refer to Appendix C, Summary of Details and Reinforcement for Section Perpendicular to Grain Page 155 for more information. It is the responsibility of the EDR to ensure the primary and secondary members have adequate capacity to resist connection forces.
7. Values for systems including the Clip Lock are tabulated in accordance with ICC-ES AC 13 and ASTM D7747. Reduced download values shown must be used in conjunction with the Clip Lock system.

Design Section

This table provides the allowable loads for connectors based on connection configurations and specific gravities. It also provides minimum secondary beam sizes for various fire-resistance ratings (FRR).

Primary Member Geometry Requirements - Beam/Girder

Table 2.8 - RICON S VS VS Geometry Requirements for Primary Member (Beam/Girder)

RICON S VS #8		Secondary Requirements (in.)									
Series	Depth	L ₁	L ₂	L ₃	L ₄	L ₅	L ₆	L ₇	L ₈	L ₉	L ₁₀
RICON S VS #8	Single	2100	1500	1500	1500	1500	1500	1500	1500	1500	1500
	Double	2100	1500	1500	1500	1500	1500	1500	1500	1500	1500
RICON S VS #10	Single	2100	1500	1500	1500	1500	1500	1500	1500	1500	1500
	Double	2100	1500	1500	1500	1500	1500	1500	1500	1500	1500

Notes:
 1. Connector design must meet all design requirements of the General Division of the Code when used with:
 2. Secondary member geometry as shown in the product literature.
 3. Minimum primary member depth shall be 100% of the depth of the secondary member.
 4. Minimum secondary member depth shall be 100% of the depth of the primary member.
 5. L₁ through L₁₀ are the required dimensions for the secondary member.

Housing Dimensions

Routing in Primary Member

Table 2.21 - Routing Dimensions for RICON S VS Housed in Primary Member

Model	L ₁	L ₂	L ₃	L ₄	L ₅	L ₆	L ₇	L ₈	L ₉	L ₁₀	R
RICON S VS #8 144 x 48	7.88 (202)	4.89 (124)	4.89 (124)	4.89 (124)	4.89 (124)	4.89 (124)	4.89 (124)	4.89 (124)	4.89 (124)	4.89 (124)	4.89 (124)
RICON S VS #8 200 x 48	8.50 (216)	5.51 (140)	5.51 (140)	5.51 (140)	5.51 (140)	5.51 (140)	5.51 (140)	5.51 (140)	5.51 (140)	5.51 (140)	5.51 (140)
RICON S VS #8 264 x 48	9.12 (232)	6.13 (156)	6.13 (156)	6.13 (156)	6.13 (156)	6.13 (156)	6.13 (156)	6.13 (156)	6.13 (156)	6.13 (156)	6.13 (156)
RICON S VS #10 144 x 48	8.50 (216)	5.51 (140)	5.51 (140)	5.51 (140)	5.51 (140)	5.51 (140)	5.51 (140)	5.51 (140)	5.51 (140)	5.51 (140)	5.51 (140)
RICON S VS #10 200 x 48	9.12 (232)	6.13 (156)	6.13 (156)	6.13 (156)	6.13 (156)	6.13 (156)	6.13 (156)	6.13 (156)	6.13 (156)	6.13 (156)	6.13 (156)
RICON S VS #10 264 x 48	9.74 (248)	6.75 (173)	6.75 (173)	6.75 (173)	6.75 (173)	6.75 (173)	6.75 (173)	6.75 (173)	6.75 (173)	6.75 (173)	6.75 (173)

Detailing Section

These renderings define key dimensions for each series of connectors in the product family.

These tables provide minimum dimensions for secondary beams, primary beams, or primary columns incorporating minimum fastener geometry and FRR.

This section provides detailed guidelines for preparing wood members to ensure proper alignment, load transfer, and connector performance. Detailed routing dimensions, including minimum tolerances, are provided to ensure proper installation and meet fire protection requirements.

General Installation Steps

Estimated installation time for a single person to install a complete RICON S VS product is shown in Table 2.20.

Table 2.20 - RICON S VS Estimated Installation Time

RICON S VS Model	Estimated Installation Time (in. min.)
144 x 48	15
200 x 48	15
264 x 48	15
144 x 72	20
200 x 72	20
264 x 72	20

Step-by-Step Installation Guidelines

1.1 Layout - Reference Points
 Begin by laying out the installation locations in the primary and secondary members using a pencil and square.
 The connector's point of reference is the bottom top of the beam. The lower structural positioning screw should be measured from that point of reference.
 The collar bolt should be at the bottom on the primary member and on the top on the secondary member.

1.2 Layout - Split Laminates
 It is recommended that vertical joints in beams be tight at the time of manufacturing. If vertical gaps between joints in adjacent pieces may occur due to wood movement, it is acceptable for typical RICON S VS products to have a maximum gap of 1/8 in. at the time of installation. If vertical gaps between joints in the beamwork, the RICON S VS structural fasteners can be installed at least 5 in. from the edge of the beam. The capacity of the fastener may be used when installed in this manner.

4.3 Screw Installation - Drill Pressure
 Do not apply excessive pressure on the drill while driving the fastener to prevent fastener loading or distortion during installation. Only apply the required force or use the recommended holder case to eliminate over-torque effects.

4.4 Screw Installation - One-Step Process
 To avoid increased torque created by stopping and restarting the drive-in process, install the screw in one run until the head is tightly seated against the side member. If necessary, a torque wrench may be used to complete installation immediately after the screw has been driven.

4.5 Screw Installation - Structural Screws
 Install properly sized V3 CSK screws in all perpendicular holes. If using a Clip Lock system, refer to Step 5.1 and Page 37 for further information.
 For the RICON S VS #8, only install 3/8" x 7-3/8" V3 CSK screws into all angled holes after all 90° horizontal screws have been installed.

4.6 Optional Measures - Clip Lock Installation
 The Clip Lock system must be installed with a modified screw pattern in the primary member. Refer to Page 37 for further details on the screw pattern for the Clip Lock.

5.0 Optional Measures - Wood Plug
 Where connectors are housed in the secondary beam, it is recommended to seal the void in the routing below the connector for aesthetics and fire protection. A wood plug may be used, and installation instructions shall be provided by the ICC.

Installation Section

General Installation Information: Includes average installation time for each connector and outlines the tools required for installation.

Step-by-Step Guidance: Provides a detailed breakdown of the installation process, including connector layout, placement of positioning screws, pilot hole recommendations, and the sequence for installing structural screws. Detailed tips to ensure precise screw installation are also included.

Special-Case Instructions: The gray boxes highlight procedures or requirements that apply only to specific scenarios, such as unique structural needs, uplift considerations, or sealing for fire protection.

General Notes to the Designer

1. Allowable loads for GIGANT and MEGANT connectors are derived in accordance with ASTM D7147-21 and allowable loads for RICON S VS connectors are based on ICC-ESR-4300 (2024).
2. Allowable loads provided are per Allowable Stress Design (ASD) and must be adjusted in accordance with all applicable adjustment factors per NDS 2024 Section 11.3.
3. Connectors in combination with carbon steel fasteners are to be used in dry service conditions only, i.e., wet service factor, $C_M = 1.0$.
4. During construction, mass timber elements may experience temporary surface wetting, potentially causing the timber surface moisture content (MC) to exceed 19%. In such cases, A3K electroplated carbon steel fasteners are acceptable for use, provided that the following three conditions are met. First, the surface wetting shall not exceed the moisture limits defined for dry service conditions for more than a few weeks per year. Second, the annual average MC during construction shall remain within the range of 10–16%. Third, the design must incorporate appropriate detailing to accommodate dimensional changes in the wood due to wetting and/or drying. If any of these conditions cannot be met, fasteners with enhanced corrosion resistance are recommended, and detailing must be adjusted accordingly.
5. Allowable loads provided incorporate a load duration factor, C_D , of 1.0 and cannot be further increased for shorter load durations. For permanent dead loads, allowable loads must be adjusted by a C_D of 0.9 in accordance with NDS 2024 Table 2.3.2.
6. Tabulated allowable loads apply to connections exposed to sustained temperatures below 100°F. When connectors are installed in wood members that will experience sustained exposure to temperatures exceeding 100°F, the allowable loads must be adjusted by the temperature factor, C_t , as described in NDS 2024.
7. Allowable loads provided are valid only when using the listed associated GIGANT SK screws with GIGANT connectors, and the listed associated ASSY screws with RICON S VS and MEGANT connectors.
8. Connectors are to be centered with the resultant vertical force, with the plates installed symmetrically about the vertical axis. Horizontal eccentricities need to be specified and the resulting rotational forces accounted for.
9. Connectors, if subjected to rotational forces, must be designed accordingly, with the Engineer of Record (EOR) specifying any necessary additional measures.
10. Appropriate lateral support must be provided for lateral stability against rotation.
11. Pilot holes may be used to facilitate fastener installation with greater precision. Pilot hole diameters shall not exceed the minor diameter, D_m , of the fastener.
12. Predrilling is required when installing connectors into Parallel Strand Lumber (PSL) and the edge of laminated veneer products to reduce the risk of splitting.
13. A hole is considered predrilled if its length matches the entire length of the fastener.
14. Installation must respect all minimum beam size requirements, including fastener geometry requirements and fire-resistance rating (FRR) requirements.



15. Within this guide, the term "primary member" refers to the supporting member (beam or column), and the term "secondary beam" refers to the supported beam, typically with the connector installed into the end grain.
16. Minimum beam sizes presented are based on geometry and FRR requirements. Allowable loads of the connector may exceed the capacity of the wood member. The EOR must ensure that all possible stress limits for the wood members, such as the shear capacity, flexural capacity, deflection limits, and other material properties, are not exceeded while maintaining a continuous load path.
17. Tabulated sample beam depths are for reference purposes only. Note that tolerances for finished glulam dimensions provided in the ANSI 117 manufacturing standard may not ensure the adequate squareness and depth required for seamless field installation. A 1/4 in. undersize in depth and a 1/8 in. undersize in width may be required. Verify all finished glulam dimensions with the timber provider.
18. When side grain or beam-end conditions cause the tensile strength of the wood perpendicular to grain to be exceeded, reinforcement must be added to ensure the connection's structural integrity. The EOR is responsible for the design of any required reinforcing screws.
19. For specific gravities, G , assigned to different timber species, refer to NDS 2024 Table 12.3.3A.
20. Members manufactured with split laminations should have the vertical joints of all laminations in contact at the time of fabrication.

General Notes to the Installer

1. Refer to detailing installation guidelines within each product chapter for additional information.
2. Carbon steel fasteners shall only be used in dry service conditions, as exposure to wet service conditions may lead to premature failure. Connections designed for dry service conditions should be protected from wetting and excessive moisture during construction.
3. During construction, mass timber elements may experience temporary surface wetting, potentially causing the timber surface moisture content (MC) to exceed 19%. In such cases, A3K electroplated carbon steel fasteners are acceptable for use, provided that the following three conditions are met. First, the surface wetting shall not exceed the moisture limits defined for dry service conditions for more than a few weeks per year. Second, the annual average MC during construction shall remain within the range of 10–16%. Third, the design must incorporate appropriate detailing to accommodate dimensional changes in the wood due to wetting and/or drying. If any of these conditions cannot be met, fasteners with enhanced corrosion resistance are recommended, and detailing must be adjusted accordingly.
4. Use a drill equipped with a feather (variable-speed) trigger to ensure proper torque management and mitigate the risk of overtorquing. Although impact guns are not expressly prohibited, their use is discouraged due to increased risk of overtorquing. If an impact gun is utilized, limit its use to short screws and maintain a continuous drive without pausing. For more information on drill selection, refer to the Installation Guidelines within each product section.
5. GIGANT connectors must be installed with the listed GIGANT SK screws, while RICON S VS and MEGANT connectors must be installed with the listed ASSY screws. Substitution of fasteners is not permitted.
6. If splitting of a wood member or fastener damage is observed prior to or during installation of the fasteners, the installation process must be stopped, and the Engineer of Record (EOR) must be contacted immediately to provide appropriate site instructions to rectify the issue.
7. Pilot holes may be used to facilitate fastener installation with greater precision. Pilot holes shall be 1 in. deep and their diameters shall not exceed the minor diameter, D_m , of the fastener.
8. For fasteners installed in a countersunk hole, a pilot hole using the Predrilling Jig is recommended to ensure proper installation of the fasteners.
9. Predrilling can help reduce the insertion torque of self-tapping fasteners. Predrilling is recommended for installation of fasteners into dry (<10% MC) Southern Yellow Pine (SYP) to reduce installation torque.
10. Screws should be fully driven in an uninterrupted process, from tip insertion to head seating. If necessary, a torque wrench may be used to complete installation immediately after initial insertion of the screw.

Beam Hanger Selection Tool

The following pre-selection table helps the designer choose the correct beam hanger system. It lists the allowable loads for each system as well as the minimum beam width and depth. More details on a specific beam hanger system can be found on the pages referenced in the table. Additional requirements, such as those relating to geometry and special connections, must also be taken into consideration where applicable.

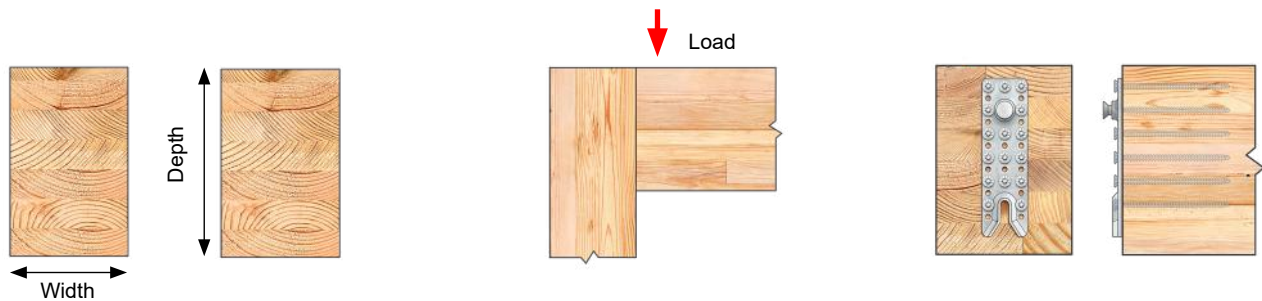

Minimum Beam Width		Minimum Beam Width		Allowable Load		Connector	
in.	[mm]	in.	[mm]	kips		Model	Page
3-15/16	[100]	6-5/16	[160]	1.2	<div style="width: 10%;"></div>	GIGANT 120 x 40	20
		7-3/32	[180]	1.9	<div style="width: 15%;"></div>	GIGANT 150 x 40	20
		8-21/32	[220]	2.5	<div style="width: 20%;"></div>	GIGANT 180 x 40	20
3-5/8	[92]	7-5/16	[186]	3.8	<div style="width: 25%;"></div>	RICON S VS 140 x 60	38
		9-11/16	[246]	4.8	<div style="width: 30%;"></div>	RICON S VS 200 x 60	38
3-15/32	[88]	16-5/32	[410]	9.8	<div style="width: 40%;"></div>	MEGANT 310 x 60	63
		20-7/8	[530]	12.8	<div style="width: 50%;"></div>	MEGANT 430 x 60	63
		25-19/32	[650]	12.8	<div style="width: 50%;"></div>	MEGANT 550 x 60	63
4-23/32	[120]	10-1/4	[260]	6.9	<div style="width: 30%;"></div>	RICON S VS 200 x 80	41
		12-19/32	[320]	8.9	<div style="width: 40%;"></div>	RICON S VS 290 x 80	41
		16-15/16	[430]	15.0	<div style="width: 60%;"></div>	RICON S VS XL 390 x 80	44
5-1/32	[128]	14-13/16	[376]	12.6	<div style="width: 45%;"></div>	MEGANT 310 x 100	67
		19-17/32	[496]	17.7	<div style="width: 65%;"></div>	MEGANT 430 x 100	67
		24-1/4	[616]	19.5	<div style="width: 75%;"></div>	MEGANT 550 x 100	67
7	[178]	14-13/16	[376]	16.3	<div style="width: 55%;"></div>	MEGANT 310 x 150	71
		19-17/32	[496]	27.2	<div style="width: 80%;"></div>	MEGANT 430 x 150	71
		24-1/4	[616]	31.7	<div style="width: 90%;"></div>	MEGANT 550 x 150	71
		30-15/16	[786]	32.6	<div style="width: 95%;"></div>	MEGANT 730 x 150	71

Notes:

1. Tabulated allowable loads are only valid for Allowable Stress Design in the US. This table is a pre-selection tool. Refer to each respective connector section and NDS 2024 for design guidelines.
2. Tabulated allowable loads are only valid for use in $G \geq 0.50$ in standard-term loading ($C_D = 1.0$). Refer to each respective connector section for additional values.
3. Tabulated allowable loads are for a single connector. Refer to the RICON S VS and MEGANT product chapters for double connector configuration capacities.
4. Tabulated minimum beam sizes are based on geometry requirements for the connector and fasteners and do not account for the fire-resistance rating (FRR) or capacity of the wood members. The EOR is responsible for verifying stress limits for the wood members. See product chapters for minimum beam size requirements for various FRR.



First Tech Federal Credit Union

Hillsboro, Oregon

GIGANT

Pre-Engineered Connection System

The GIGANT is a pre-engineered system for beam-to-column and beam-to-beam connections. Manufactured from mild steel, it consists of two identical parts and is suitable for use in timber framing, log home building, and mass and heavy timber construction. Easy to install with structural screws perpendicular to its plates, the GIGANT can be fully concealed or visible.



Pre-Installable

Pre-installable in a controlled shop environment for a faster on-site installation



Drop-in Installation

A fast, streamlined & repeatable installation process that significantly enhances efficiency



Light Frame

Best used in timber framing & log home building



Fully Concealable

Easy to conceal connections, enhancing architectural wood features

Design

- Wood-to-Wood Design Values

Detailing

- General Detailing Information
- GIGANT Geometry Requirements
- Additional Hanger Placement Considerations

Installation

- Installation Considerations
- Routing Information
- Tool Requirements
- Step-by-Step Installation Guidelines

CERTIFICATIONS



ETA-10/0189 2019

GIGANT Overview



Table 1.1 - GIGANT Hardware Package Installation Overview

GIGANT		Plate Qty.	Fasteners				Installation Time min.
Series	Model		Primary Member		Secondary Member		
			Type	Qty.	Type	Qty.	
40	GIGANT 120 x 40	2	GIGANT SK 3/8" x 3-1/8"	3	GIGANT SK 3/8" x 4-3/4"	3	4
	GIGANT 150 x 40	2	GIGANT SK 3/8" x 3-1/8"	4	GIGANT SK 3/8" x 4-3/4"	4	5
	GIGANT 180 x 40	2	GIGANT SK 3/8" x 3-1/8"	6	GIGANT SK 3/8" x 4-3/4"	6	5

Notes:

1. Subsequent tabulated capacities in this chapter assume connectors are installed with fasteners specified in this table.
2. The estimated installation time is based on a time study and includes steps for layout and positioning and structural screw installation for both plates. Refer to the General Installation Steps (Page 28) for more information.



Product Kit Details



GIGANT SK

GIGANT Plates

GIGANT Design Information

Wood-to-Wood Design Values

Table 1.2 - Allowable Loads for GIGANT in Wood-to-Wood Connections

Model	Minimum Secondary Beam Section Dimensions [in.]			Specific Gravity [G]	Allowable Download [lb.]
	No FRR	1-hr FRR	2-hr FRR		
GIGANT 120 x 40	3-15/16 x 6-5/16	5 x 7-23/32	7-19/32 x 9-13/32	≥ 0.42	1,090
				≥ 0.50	1,230
GIGANT 150 x 40	3-15/16 x 7-3/32	5 x 8-23/32	7-19/32 x 10-13/32	≥ 0.42	1,640
				≥ 0.50	1,910
GIGANT 180 x 40	3-15/16 x 8-21/32	5 x 10-5/32	7-19/32 x 11-27/32	≥ 0.42	2,180
				≥ 0.50	2,460

Notes:

1. Connection design must meet all relevant requirements of the General Notes to the Designer section.
2. Tabulated allowable loads are applicable for wood-to-wood connections only.
3. Screw installation must follow the patterns presented in the Installation section.
4. Tabulated allowable loads are IBC-compliant in accordance with ASTM D7147.
5. Tabulated values that are not dependent on FRR, as well as those for secondary beams with no FRR, are based on testing conducted in accordance with ASTM D7147.
6. Minimum dimensions for beams with an FRR are based on minimum wood cover requirements specified in NDS 2024 Chapter 16.5. Beam sizes satisfying an FRR assume a fire-resistant joint compliant with FDS 2024 Section 2.5.1.3. and that any void below the connector in the routing has been sealed with a wood plug.
7. Tabulated allowable loads assume members are positioned at beam depths that do not require reinforcement. Refer to Appendix C: Survey of Literature on Reinforcement for Tension Perpendicular to Grain (Page 100) for more information. It is the responsibility of the EOR to ensure the primary and secondary members have adequate capacity to resist connection forces.

GIGANT Series - Geometry Requirements

GIGANT Series - Connector Geometry

Table 1.3 - GIGANT Geometry

Connector Geometry	Model		
	GIGANT 120 x 40	GIGANT 150 x 40	GIGANT 180 x 40
	[in.]		
H ₁	4-21/32	5-29/32	7-5/32
H ₂	4-13/32	5-21/32	6-15/16
W	1-9/16	1-9/16	1-9/16
T	1-1/32	1-1/32	1-1/32

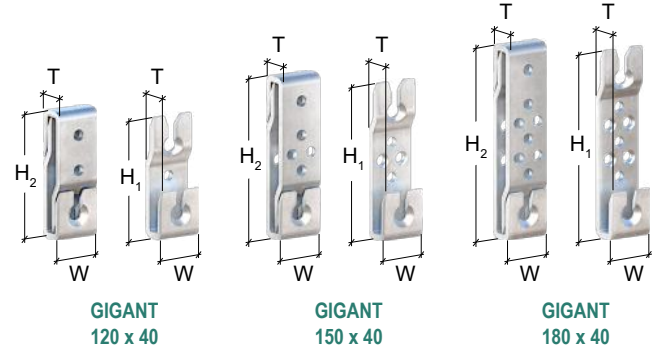

Note: Refer to Appendix D: Product Specifications (Page 109) for additional product specifications.

Secondary Member Geometry Requirements

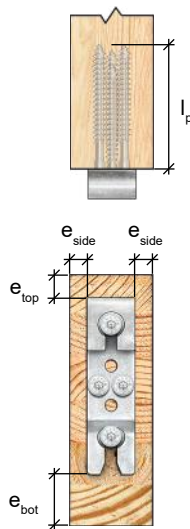

Unhoused

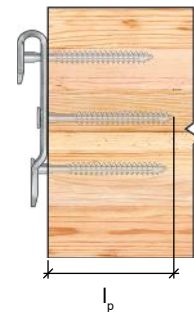

Housed

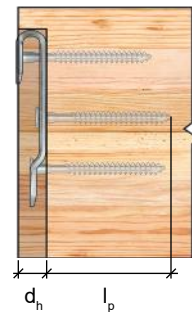
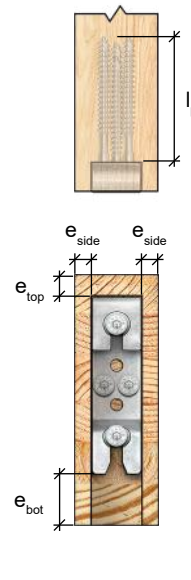

Table 1.4 - GIGANT Geometry Requirements for Secondary Member

Model	Minimum Dimensions [in.]								
	l_p	e_{top}	No FRR		1-hr FRR		2-hr FRR		d_h
			e_{side}	e_{bot}	e_{side}	e_{bot}	e_{side}	e_{bot}	
GIGANT 120 x 40	4-11/32	13/16	1-3/16	1-1/16	1-23/32	2-15/32	3	4-5/32	1
GIGANT 150 x 40	4-11/32	19/32	1-3/16	13/16	1-23/32	2-15/32	3	4-5/32	1
GIGANT 180 x 40	4-11/32	3/4	1-3/16	31/32	1-23/32	2-15/32	3	4-5/32	1

Notes:

1. Connection design must meet all relevant requirements of the General Notes to the Designer section.
2. Screw installation must follow the patterns presented in the Installation section.
3. Tabulated values are minimum requirements unless noted otherwise. Tabulated values for l_p are fixed. Tabulated values for d_h are maximum values based on a gap of 0.039 in. between the primary and secondary member. Larger gaps (such as a typical gap of 1/8 in.) will reduce d_h accordingly.
4. Tabulated values that are not dependent on FRR, as well as those for secondary beams with no FRR, are based on testing conducted in accordance with ASTM D7147.
5. Minimum dimensions for beams with an FRR are based on minimum wood cover requirements specified in NDS 2024 Chapter 16.5. Beam sizes satisfying an FRR assume a fire-resistant joint compliant with FDS 2024 Section 2.5.1.3. and that any void below the connector in the routing has been sealed with a wood plug.

Primary Member Geometry Requirements - Beam/Girder



Unhoused

Housed

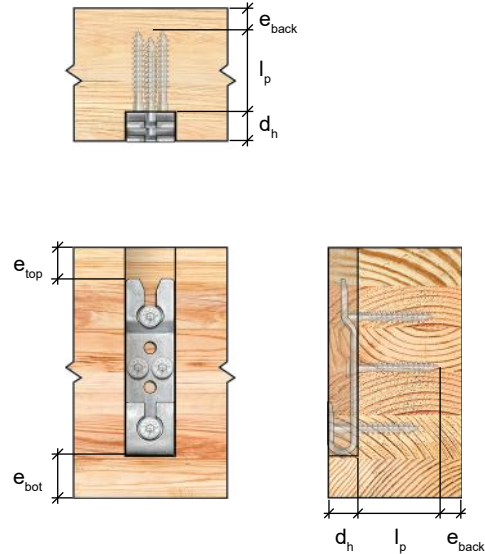
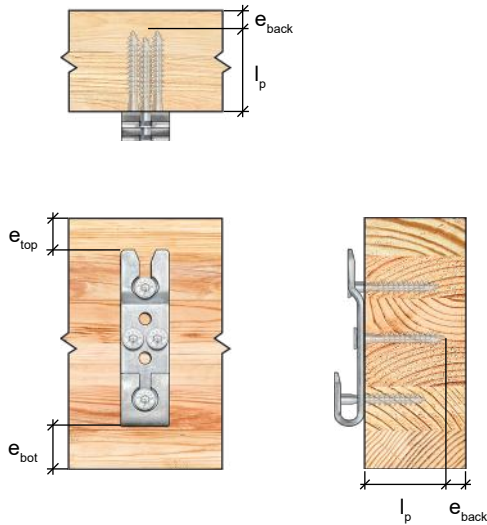

Table 1.5 - GIGANT Geometry Requirements for Primary Member (Beam/Girder)

Model	Minimum Dimensions [in.]								
	l_p	e_{top}	No FRR		1-hr FRR		2-hr FRR		d_h
			e_{bot}	e_{back}	e_{bot}	e_{back}	e_{bot}	e_{back}	
GIGANT 120 x 40	2-3/4	1-1/16	13/16	13/32	2-1/4	1-23/32	3-15/16	3	1
GIGANT 150 x 40	2-3/4	13/16	19/32	13/32	2-1/4	1-23/32	3-15/16	3	1
GIGANT 180 x 40	2-3/4	31/32	3/4	13/32	2-1/4	1-23/32	3-15/16	3	1

Notes:

1. Connection design must meet all relevant requirements of the General Notes to the Designer section.
2. Screw installation must follow the patterns presented in the Installation section.
3. Tabulated values are minimum requirements unless noted otherwise. Tabulated values for l_p are fixed. Tabulated values for d_h are maximum values based on a gap of 0.039 in. between the primary and secondary member. Larger gaps (such as a typical gap of 1/8 in.) will reduce d_h accordingly.
4. Tabulated values that are not dependent on FRR, as well as those for primary beams with no FRR, are based on testing conducted in accordance with ASTM D7147.
5. Minimum dimensions for beams with an FRR are based on minimum wood cover requirements specified in NDS 2024 Chapter 16.5. Beam sizes satisfying an FRR assume a fire-resistant joint compliant with FDS 2024 Section 2.5.1.3. and that any void below the connector in the routing has been sealed with a wood plug.
6. Values for e_{top} are minimum requirements based on minimum end and edge distance, and may need to be adjusted to align with the hanger placement in the secondary beam.

Primary Member Geometry Requirements - Column



Unhoused

Housed

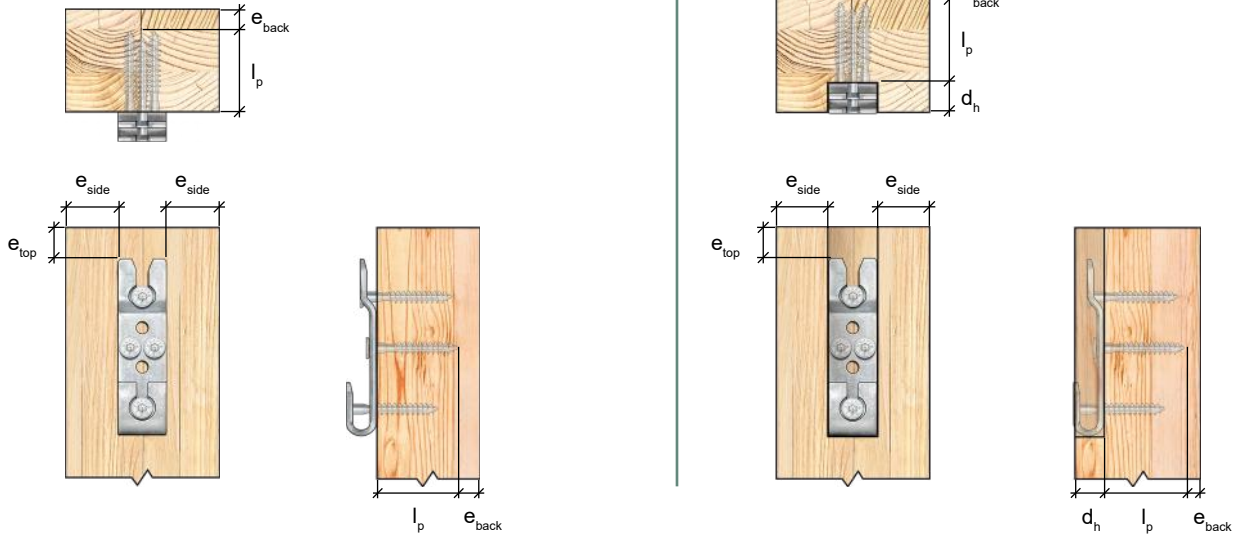

Table 1.6 - GIGANT Geometry Requirements for Primary Member (Column)

Model	Minimum Dimensions [in.]								
	l_p	e_{top}	No FRR		1-hr FRR		2-hr FRR		d_h
			e_{side}	e_{back}	e_{side}	e_{back}	e_{side}	e_{back}	
GIGANT 120 x 40	2-3/4	1-1/16	1-3/16	13/32	1-23/32	1-23/32	3	3	1
GIGANT 150 x 40	2-3/4	13/16	1-3/16	13/32	1-23/32	1-23/32	3	3	1
GIGANT 180 x 40	2-3/4	31/32	1-3/16	13/32	1-23/32	1-23/32	3	3	1

Notes:

1. Connection design must meet all relevant requirements of the General Notes to the Designer section.
2. Screw installation must follow the patterns presented in the Installation section.
3. Tabulated values are minimum requirements unless noted otherwise. Tabulated values for l_p are fixed. Tabulated values for d_h are maximum values based on a gap of 0.039 in. between the primary and secondary member. Larger gaps (such as a typical gap of 1/8 in.) will reduce d_h accordingly.
4. Tabulated values that are not dependent on FRR, as well as those for primary columns with no FRR, are based on minimum fastener end distances specified in AC 233 for fasteners with pre-drilled holes, a minimum depth to prevent the screw tip from penetrating through the column, and testing conducted in accordance with ASTM D7147.
5. Minimum dimensions for columns with an FRR are based on minimum wood cover requirements specified in NDS 2024 Chapter 16.5. Column sizes satisfying an FRR assume a fire-resistant joint compliant with FDS 2024 Section 2.5.1.3 and that any void below the connector in the routing has been sealed with a wood plug.
6. Values for e_{top} are minimum requirements based on minimum end and edge distance, and may need to be adjusted to align with the hanger placement in the secondary beam.

Additional Detailing Considerations

Geometry Requirements for Columns with Multiple Beam Hangers

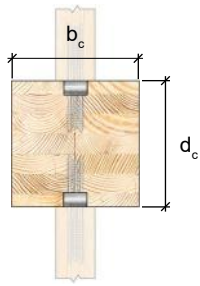

Hangers on Opposing Faces of a Square Column

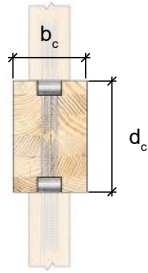

Hangers on Opposing Faces of a Rectangular Column

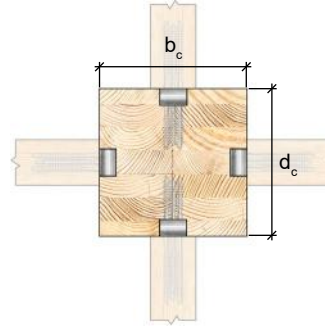

Hanger on Each Face of a Square Column

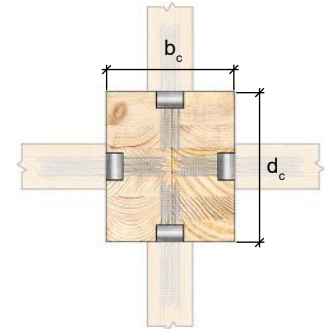

Hanger on Each Face of a Rectangular Column

Table 1.7 - Minimum Column Sizes for Multiple GIGANT Connectors

Model	Minimum Column Section Dimensions, $b_c \times d_c$ [in. x in.]					
	Hangers on Opposing Faces of a Square Column			Hangers on Opposing Faces of a Rectangular Column		
	No FRR	1-hr FRR	2-hr FRR	No FRR	1-hr FRR	2-hr FRR
GIGANT 120 x 40	8-1/32 x 8-1/32	8-1/32 x 8-1/32	8-1/32 x 8-1/32	3-15/16 x 8-1/32	5 x 8-1/32	7-19/32 x 8-1/32
GIGANT 150 x 40	8-1/32 x 8-1/32	8-1/32 x 8-1/32	8-1/32 x 8-1/32	3-15/16 x 8-1/32	5 x 8-1/32	7-19/32 x 8-1/32
GIGANT 180 x 40	8-1/32 x 8-1/32	8-1/32 x 8-1/32	8-1/32 x 8-1/32	3-15/16 x 8-1/32	5 x 8-1/32	7-19/32 x 8-1/32

Model	Minimum Column Section Dimensions, $b_c \times d_c$ [in. x in.]					
	Hanger on Each Face of a Square Column			Hangers on Each Face of a Rectangular Column		
	No FRR	1-hr FRR	2-hr FRR	No FRR	1-hr FRR	2-hr FRR
GIGANT 120 x 40	8-17/32 x 8-17/32	8-17/32 x 8-17/32	8-17/32 x 8-17/32	3-15/16 x 8-17/32	5 x 8-17/32	7-19/32 x 8-17/32
GIGANT 150 x 40	9-5/16 x 9-5/16	9-5/16 x 9-5/16	9-5/16 x 9-5/16	3-15/16 x 9-5/16	5 x 9-5/16	7-19/32 x 9-5/16
GIGANT 180 x 40	9-5/16 x 9-5/16	9-5/16 x 9-5/16	9-5/16 x 9-5/16	3-15/16 x 9-5/16	5 x 9-5/16	7-19/32 x 9-5/16

Notes:

1. Tabulated column section dimensions are minimum values based on a 1/2 in. clearance between screw tips, minimum edge and end distances, and minimum wood cover requirements for FRR. Refer to Geometry Requirements for further details.
2. It is the responsibility of the EOR to ensure the primary and secondary members have adequate capacity to resist connection forces.
3. Tabulated column section dimensions assume hangers are centered within each column face and are housed in the column as shown.

Hanger Placement Considerations

The hanger placement relative to the height of the beam can impact the need for reinforcement. Connectors in the primary member should have the uppermost fastener in the top 30% of the member depth ($0.3d$), as shown in the bottom left figure. Connectors in the secondary member should have the lowermost fastener in the bottom 30%, as shown in the bottom right figure. Outside of these zones, the primary and secondary members should be checked for splitting to determine if reinforcement is required. For further information, refer to Appendix C: Survey of Literature on Reinforcement for Tension Perpendicular to Grain (Page 100).

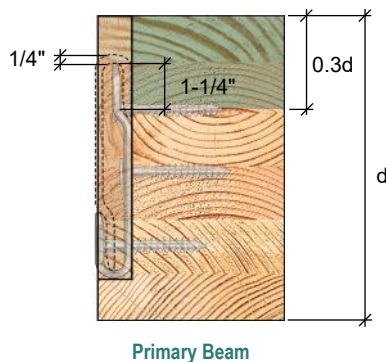

Primary Beam

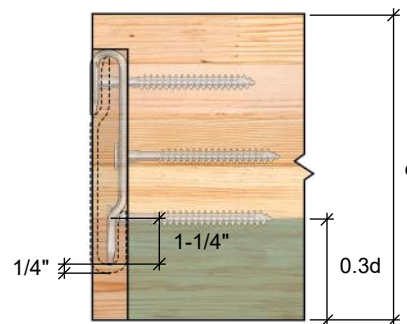

Secondary Beam

Housing Details

Housing Possibilities

Primary Beam Housing

- Most common housing for concealed installation
- Concealed from below



Secondary Beam Housing

- Joist housing from bottom up
- Concealed from below with a wood plug



Secondary Beam Through Housing

- Full-depth housing in joist
- Concealed from below with a wood plug
- May simplify fabrication



Housing and Surface Detailing



Surface-Mounted



Housed in Primary Member (Column)



Housed in Primary Member (Girder)



Housed in Secondary Member (Joist or Purlin)

Parallel Surface: The members must be parallel at the location of the connection to ensure proper hanger alignment and load transfer.

Gap Size: The gap size between wood members balances installation ease and fire performance, with larger gaps simplifying installation but reducing fire protection. The gap is typically sized at 1/8 in. [3.2 mm] to address fire protection considerations as outlined in FDS 2024 [refer to Appendix A: Fire Protection (Page 92)]. For proper installation, a minimum gap of 0.039 in. [1 mm] is required to allow the secondary member to slide into place.

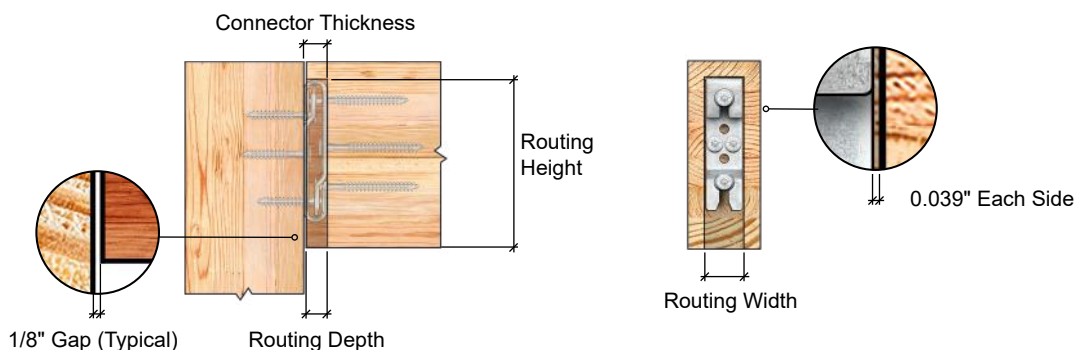

Routing Depth: The routing depth is the depth of the housing, d_n , noted in the Geometry Requirements and Routing Details sections. This depth takes into account the thickness of the connector and the gap between members (assumed as 0.039 in. [1 mm] herein - larger gaps will reduce d_n accordingly).

Routing Width: It is recommended to allow a clearance of 0.039 in. [1 mm] on each side of the connector, resulting in a routing width of 1.654 in. [42 mm] for the GIGANT connector.

Routing Height: The routing height must be coordinated with the EOR. The height of the connector in the beam section has an impact on connector performance. Refer to Hanger Placement Considerations section (Page 23) for further information.

Housing Dimensions

Routing in Primary Member

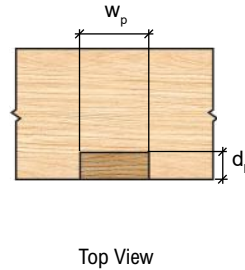
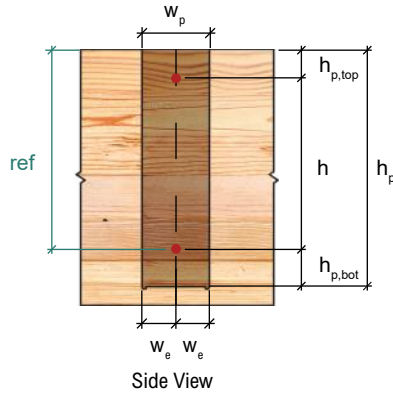

Fastener Orientation
 Structural Positioning Screws
 (Refer to Fastener Layout on Page 27)

Table 1.8 - Routing Dimensions for GIGANT Housed in Primary Member

Model	Routing Dimensions, in. [mm]						
	h_p	$h_{p,top}$	h	$h_{p,bot}$	w_p	w_e	d_h
GIGANT 120 x 40	5.512 [140]	1.969 [50]	2.244 [57]	2.087 [53]	1.654 [42]	0.827 [21]	1.004 [25.5]
GIGANT 150 x 40	6.535 [166]	1.723 [44]	3.504 [89]	1.850 [47]	1.654 [42]	0.827 [21]	1.004 [25.5]
GIGANT 180 x 40	7.953 [202]	1.890 [48]	4.764 [121]	2.008 [48]	1.654 [42]	0.827 [21]	1.004 [25.5]

Notes:

1. Tabulated values are general guidelines for routing requirements. The EOR and fabricator are responsible for ensuring final routing dimensions account for all project-specific conditions.
2. Tabulated values are minimum requirements unless noted otherwise. Tabulated values for h are fixed. Tabulated values for d_h are maximum allowable.
3. Tabulated values account for 0.039 in. [1 mm] on each side of and below the hanger. Larger installation tolerances will increase height and width values accordingly.
4. Tabulated values are based on a gap of 0.039 in. [1 mm] between the primary and secondary member. Larger gaps (such as a typical gap of 1/8 in.) will reduce d_h accordingly.
5. Refer to the Geometry Requirements tables for each respective beam hanger for additional information.
6. Tabulated values assume square corners. Manufacturers should adjust these values based on their specific routing bit sizes. In order to account for the round corner created by routing tools, 1/4 in. overrun is permitted at the inside corners as indicated on the image above.

Routing in Secondary Member

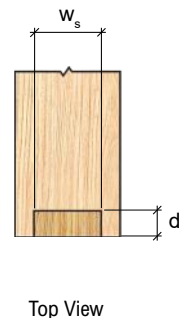
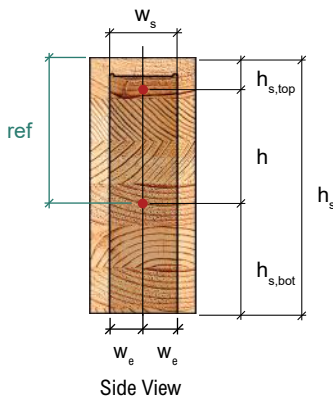

Table 1.9 - Routing Dimensions for GIGANT Housed in Secondary Member (Beam-End)

Model	Routing Dimensions, in. [mm]						
	h_s	$h_{s,top}$	h	$h_{s,bot}$	w_s	w_e	d_h
GIGANT 120 x 40	5.512 [140]	1.732 [44]	2.244 [57]	2.323 [59]	1.654 [42]	0.827 [21]	1.004 [25.5]
GIGANT 150 x 40	6.535 [166]	1.496 [38]	3.504 [89]	2.087 [53]	1.654 [42]	0.827 [21]	1.004 [25.5]
GIGANT 180 x 40	7.953 [202]	1.654 [42]	4.764 [121]	2.244 [57]	1.654 [42]	0.827 [21]	1.004 [25.5]

Notes:

1. Tabulated values are general guidelines for routing requirements. The EOR and fabricator are responsible for ensuring final routing dimensions account for all project-specific conditions.
2. Tabulated values are minimum requirements unless noted otherwise. Tabulated values for h are fixed. Tabulated values for d_h are maximum allowable.
3. Tabulated values account for 0.039 in. [1 mm] on each side of and below the hanger. Larger installation tolerances will increase height and width values accordingly.
4. Tabulated values are based on a gap of 0.039 in. [1 mm] between the primary and secondary member. Larger gaps (such as a typical gap of 1/8 in.) will reduce d_h accordingly.
5. Refer to the Geometry Requirements tables for each respective beam hanger for additional information.
6. Tabulated values assume square corners. Manufacturers should adjust these values based on their specific routing bit sizes. In order to account for the round corner created by routing tools, 1/4 in. overrun is permitted at the inside corners as indicated on the image above.

GIGANT Installation Configurations

Possible Installation Configurations for GIGANT

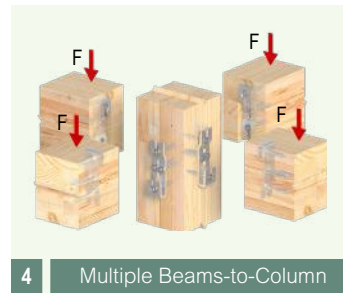
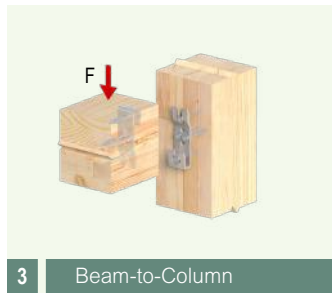
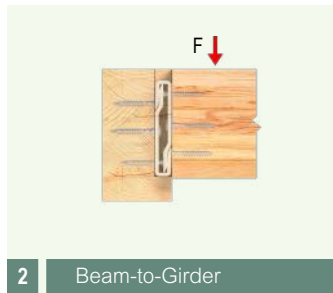
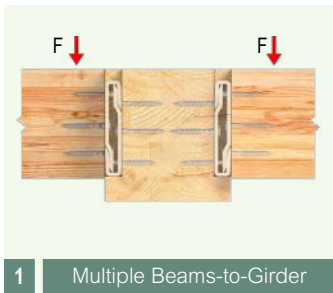
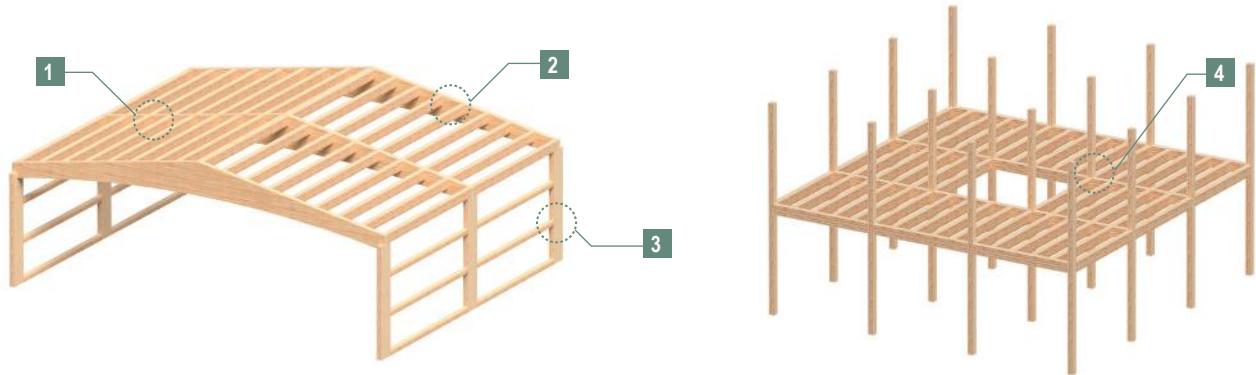

1 Multiple Beams-to-Girder

2 Beam-to-Girder

3 Beam-to-Column

4 Multiple Beams-to-Column

Beam Length Tolerances and Sequencing

Installation sequencing is important, especially for buildings with multiple bays of post-and-beam framing. It is recommended to install the beams starting from one end of the building and progress along the column line. The last beam can be produced slightly over length and cut to size on-site to help address any dimensional tolerance challenges. The GIGANT features tapered openings that facilitate installation by guiding the secondary beam into place. Beams positioned up to 1/4 in. to either side or slightly out from the primary member will self-center as they slide down.

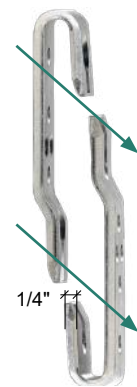

GIGANT Installation Tolerance

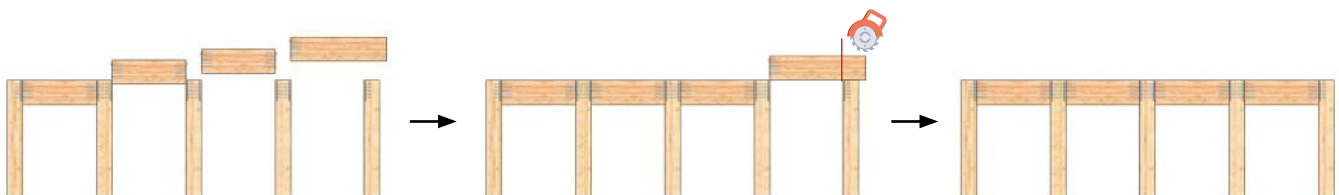

GIGANT Installation Procedure

Tool Requirements

Tools - Use the Correct Bit

Fasteners should only be driven using appropriately sized star bits. This ensures good centering and positioning with optimal torque transmission.

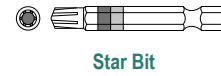

Tools - Use the Correct Drill

Use low-RPM, high-torque drills equipped with a feather (variable speed) trigger to install fasteners. Avoid excessive acceleration and deceleration during the drive-in process. Do not overtorque fasteners. Although impact guns are not expressly prohibited, their use is discouraged - particularly for beam hanger systems - due to an increased risk of overtorquing. Use the appropriate drill chuck size according to the fastener.

Table 1.10 - Recommended Torque, Drill Bits, and Power Drill

Nominal Fastener Diameter [D]		HSS Drill Bit Size	Power Drill Voltage	Allowable Insertion Torque
in.	[mm]	in.	V	lb.·ft.
3/8	[10]	1/4	60	22.13

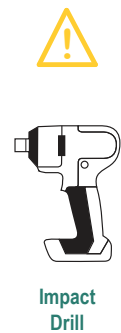
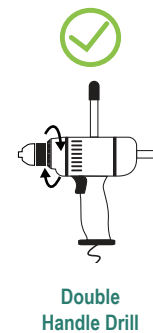
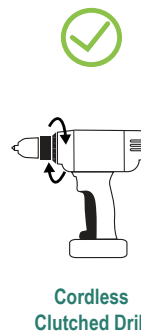

Fastener Layout

Fastener Orientation

- Structural Positioning Screws
- Horizontal Screws

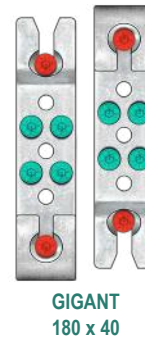
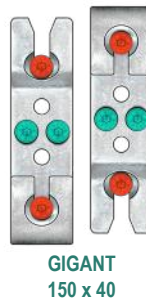
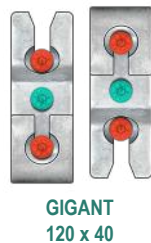

General Installation Steps

Estimated Installation Time

The estimated time for a single person to install a complete GIGANT product is shown in Table 1.11. The process includes the following steps:

1. Layout (~25%–30%)
2. Positioning (~40%–50%)
3. Screw Installation (~20%–30%)
4. Optional Measures (not included in the time installation % breakdown)

The estimated installation time can be improved upon with efficient fabrication and site practices such as:

1. Drilling pilot holes for the structural positioning screws at the time of fabrication
2. Utilizing templates to drill pilot holes for structural screws
3. Optimizing beam positioning to reduce worker fatigue

Table 1.11 - GIGANT Estimated Installation Times

Model	Average Installation Time [min.]
GIGANT 120 x 40	4
GIGANT 150 x 40	5
GIGANT 180 x 40	5

Step-by-Step Installation Guidelines

1.1 Layout - Reference Points

Begin by laying out the installation locations in the primary and secondary members using a pencil and square.

The connector's point of reference is the top of the beam. The **lower structural positioning screw** should be measured from that point of reference.

The **hook** should be at the **bottom** on the primary member and on the **top** on the secondary member. The structural fasteners will act as collar bolts when installed.

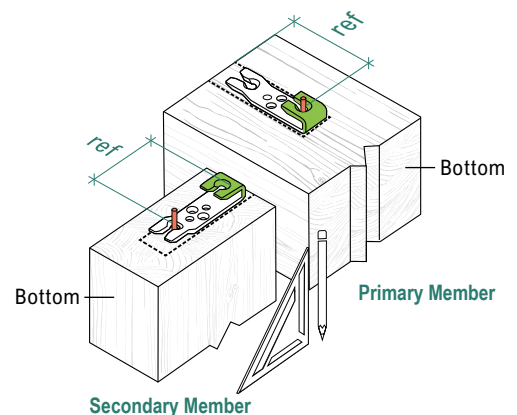

1.2 Layout - Split Lamination Considerations

It is recommended that gaps in split lamination glulam beams be tight at the time of manufacturing. Gaps between adjacent plies may occur due to wood shrinkage. Such gaps are not compatible with GIGANT installation because wood will shrink and swell and cause checks.

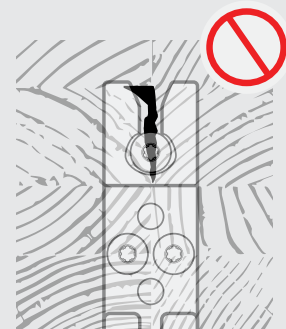

2.1 Positioning - Structural Positioning Screw Installation

Structural positioning screws ensure accurate placement of the GIGANT connector. Install one structural positioning screw into the center hole at the top of the plate for the primary member and into the bottom of the plate for the secondary member. Check to ensure alignment is maintained, and then install another structural positioning screw into the center hole at the opposite end of the plate. The second structural positioning screw will be installed in the lip of the connector. Ensure the screw is not overdriven so the connector lip does not bend.

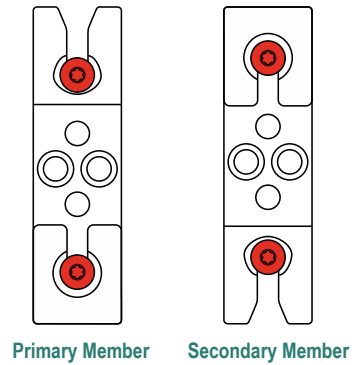

3.1 Screw Installation - Align Drill Bit Axis

Align the drill bit axis parallel to the fastener axis during installation to allow proper torque transmission and to avoid stripping.

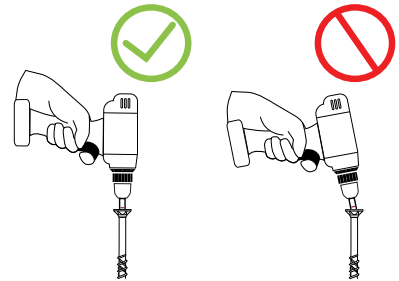

3.2 Screw Installation - Decrease RPM

To avoid overtorquing the screw, decrease the rotation speed about 1/2 in. away from the final installed position. This is crucial to prevent wood crushing due to overtorquing, which can impact beam hanger tolerances, potentially impeding overall connection assembly. This is especially important when using an impact drill.

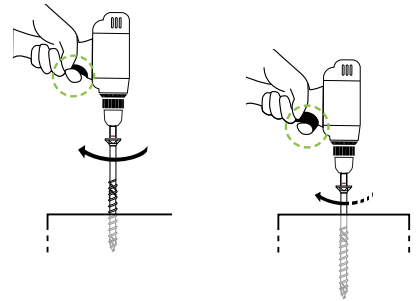

3.3 Screw Installation - Drill Pressure

Do not apply excessive pressure on the drill while driving the fastener to prevent fastener buckling or deviation during installation. Only apply the required force or use the recommended holder case to eliminate cam-out effects.



3.4 Screw Installation - One-Step Process

To avoid increased torque peaks caused by stopping and restarting the drive-in process, install the screw in one run until the head is lightly seated against the side member.

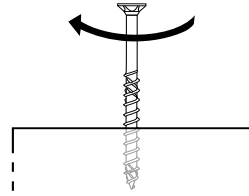

3.5 Screw Installation - Structural Screws

Install properly sized GIGANT screws in all perpendicular holes.

For the primary member, use 3/8 in. x 3-1/8 in. screws.

For the secondary member (in end-grain), use 3/8 in. x 4-3/4 in. screws.

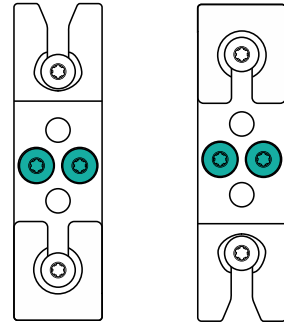

Horizontal Screw
Primary Member Secondary Member

4.1 Optional Measures - Wood Plug

Where connectors are housed in the secondary beam, it is recommended to seal the void in the routing below the connector for aesthetics and fire protection. A wood plug may be used, and installation instructions shall be provided by the EOR.

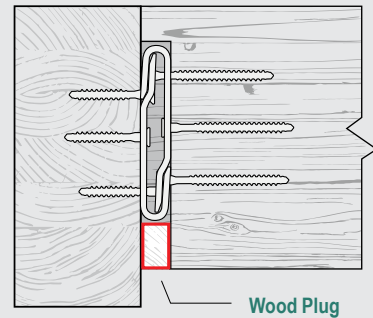

Wood Plug



Chemeketa Agricultural Complex

Salem, Oregon



Brookhaven City Centre

Brookhaven, Atlanta, Georgia

RICON S VS

Pre-Engineered Connection System

The RICON S VS connector is an ICC-certified, pre-engineered, beam-to-column and beam-to-beam connector manufactured from mild steel with a welded collar bolt. It consists of two identical parts and is suitable for use in all timber and hybrid-timber construction applications. The RICON S VS has been extensively tested for the North American market.



Pre-Installable

Pre-installable in a controlled shop environment for a faster on-site installation



Fire-Resistance-Rated

Fire-resistance rating up to 2 hours per NDS 2024.



Interstory Drift Performance-Tested

Drift ratio exceeding 4% in quasi-static rotational testing



Hybrid Construction Compatible

Can be installed in wood-to-wood or wood-to-steel beam or embed plate



Fully Concealable

Easy to conceal connections, enhancing architectural wood features



Drop-in Installation

A fast, streamlined & repeatable installation process that significantly enhances efficiency

Design

- Wood-to-Wood Design Values
- Wood-to-Steel Design Values

Detailing

- General Detailing Information
- Detailing RICON S VS 60 Series
- Detailing RICON S VS 80 Series
- Detailing RICON S VS XL Series
- Additional Hanger Placement Considerations

Installation

- Installation Considerations
- Routing Information
- Tool Requirements
- Step-by-Step Installation Guidelines

CERTIFICATIONS



ICC-ESR-4300

ISO 50001

Energy Management System



ETA-10/0189 2019

RICON S VS Overview

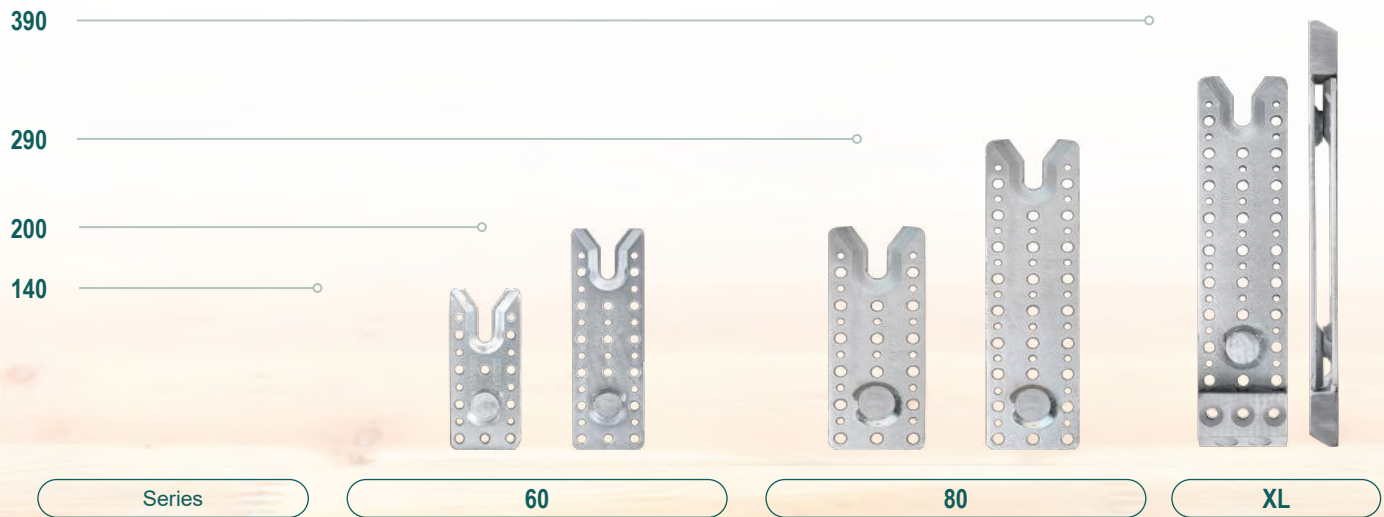

Table 2.1 - RICON S VS Hardware Package Installation Overview

RICON S VS		Plate Qty.	Fasteners				Installation Time min.
Series	Model		Primary Member		Secondary Member		
			Type	Qty.	Type	Qty.	
60	RICON S VS 140 x 60	2	VG CSK 5/16" x 3-1/8"	10	VG CSK 5/16" x 6-1/4"	10	9
	RICON S VS 200 x 60	2	VG CSK 5/16" x 3-1/8"	16	VG CSK 5/16" x 6-1/4"	16	13
80	RICON S VS 200 x 80	2	VG CSK 3/8" x 4"	16	VG CSK 3/8" x 7-7/8"	16	13
	RICON S VS 290 x 80	2	VG CSK 3/8" x 4"	20	VG CSK 3/8" x 7-7/8"	20	14
XL	RICON S VS XL 390 x 80	2	VG CSK 3/8" x 4"	28	VG CSK 3/8" x 7-7/8"	30	20
			VG CSK 3/8" x 7-7/8"	2			



Product Kit Details



Notes:

- Subsequent tabulated capacities in this chapter assume connectors are installed with ASSY VG CSK fasteners specified in this table and in accordance with ICC-ESR 3178 (2024).
- The estimated installation time is based on a time study and includes steps for layout and positioning, drilling a 1 in. deep pilot hole for each fastener, and structural screw installation for both plates. Refer to the General Installation Steps (Page 54) for more information.

RICON S VS Seismic Performance

MTC has conducted extensive quasi-static, interstory, and component testing on the RICON S VS connector. The results have demonstrated its robust performance under both axial and drift demands.

- The RICON S VS connector is capable of resisting axial forces in excess of 5% of its download capacity while fully loaded in accordance with ASCE 7-22 Sections 1.4.3 and 12.1.4.
- The RICON S VS can accommodate drifts of over 4% while fully loaded, which satisfies the drift limits specified in ASCE 7-22 Table 12-12.1.

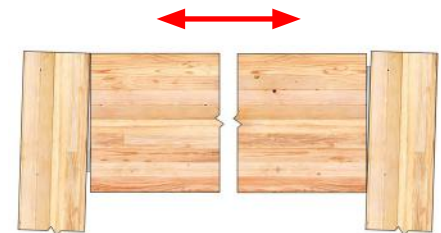

Contact MTC Technical Support for additional details for accommodating seismic loads in your design.

RICON S VS Design Information

Wood-to-Wood Design Values

Table 2.2 - Allowable Loads for RICON S VS in Wood-to-Wood Connections

RICON S VS		Minimum Secondary Beam Section Dimensions [in.]			Specific Gravity [G]	Allowable Loads [lb.]		
						Download w/o Clip Lock	Download w/ Clip Lock	Uplift w/ Clip Lock
Model	Configuration	No FRR	1-hr FRR	2-hr FRR				
RICON S VS 140 x 60	Single	3-5/8 x 7-5/16	5-25/32 x 9-11/32	8-3/8 x 11-1/16	≥ 0.42	2,740	1,920	1,670
					≥ 0.50	3,780	2,650	
	Double	6-5/16 x 7-5/16	8-15/32 x 9-11/32	11-1/16 x 11-1/16	≥ 0.42	4,660	3,260	1,670
					≥ 0.50	6,410	4,490	
RICON S VS 200 x 60	Single	3-5/8 x 9-11/16	5-25/32 x 11-23/32	8-3/8 x 13-7/16	≥ 0.42	4,080	3,300	1,670
					≥ 0.50	4,780	3,870	
	Double	6-5/16 x 9-11/16	8-15/32 x 11-23/32	11-1/16 x 13-7/16	≥ 0.42	6,650	5,390	1,670
					≥ 0.50	8,120	6,580	
RICON S VS 200 x 80	Single	4-23/32 x 10-1/4	6-9/16 x 12-1/4	9-5/32 x 13-31/32	≥ 0.42	5,600	4,540	2,420
					≥ 0.50	6,880	5,570	
	Double	8-9/32 x 10-1/4	10-1/8 x 12-1/4	12-11/16 x 13-31/32	≥ 0.42	9,820	7,950	2,420
					≥ 0.50	12,030	9,740	
RICON S VS 290 x 80	Single	4-23/32 x 12-19/32	6-9/16 x 14-5/8	9-5/32 x 16-11/32	≥ 0.42	6,620	5,630	2,420
					≥ 0.50	8,900	7,570	
	Double	8-9/32 x 12-19/32	10-1/8 x 14-5/8	12-11/16 x 16-11/32	≥ 0.42	11,890	10,110	2,420
					≥ 0.50	15,570	13,230	
RICON S VS XL 390 x 80	Single	4-23/32 x 16-15/16	6-9/16 x 19-3/16	9-5/32 x 20-7/8	≥ 0.42	12,400	11,040	2,420
					≥ 0.50	15,000	13,350	
	Double	8-9/32 x 16-15/16	10-1/8 x 19-3/16	12-11/16 x 20-7/8	≥ 0.42	22,100	19,670	2,420
					≥ 0.50	26,240	23,350	

Notes:

1. Connection design must meet all relevant requirements of the General Notes to the Designer section.
2. Listed allowable loads are applicable for wood-to-wood connections only.
3. Screw installation must follow the patterns presented in the Installation section.
4. Allowable single-configuration load values for $G \geq 0.50$ are certified in ICC-ESR-4300 (2024). Values for $G = 0.42$ are IBC-compliant in accordance with ASTM D7147.
5. Tabulated values that are not dependent on FRR, as well as those for secondary beams with no FRR, are based on minimum end and edge distances.
6. Minimum dimensions for beams with an FRR are based on minimum wood cover requirements specified in NDS 2024 Chapter 16.5. Beam sizes satisfying an FRR assume a fire-resistant joint compliant with FDS 2024 Section 2.5.1.3 and that any void below the connector in the routing has been sealed with a wood plug.
7. Tabulated capacities assume members are positioned at beam depths that do not require reinforcement. Refer to Appendix C: Survey of Literature on Reinforcement for Tension Perpendicular to Grain (Page 100) for more information. It is the responsibility of the EOR to ensure the primary and secondary members have adequate capacity to resist connection forces.
8. Values for systems including the Clip Lock are derived in accordance with ICC-ES AC 13 and ASTM D7147. The Clip Lock system requires the removal of structural fasteners for proper installation. Therefore, the reduced download values shown must be used in conjunction with the Clip Lock system. For more information on the Clip Lock system, refer to Page 37.

Wood-to-Steel Design Values

Table 2.3 - Allowable Loads for RICON S VS in Wood-to-Steel Connections

RICON S VS		Primary Member		Secondary Member	
		Weld Requirements		Specific Gravity [G]	Allowable Download [lb.]
		Min. Weld Size [in.]	Min. Weld Length [in.]		
RICON S VS 140 x 60	Single	3/16	2-3/4	> 0.42	2,740
				> 0.50	3,780
RICON S VS 200 x 60	Single		4	> 0.42	4,080
				> 0.50	4,780
RICON S VS 200 x 80	Single		4	> 0.42	5,600
				> 0.50	6,880
RICON S VS 290 x 80	Single	5-1/2	> 0.42	6,620	
			> 0.50	8,900	
RICON S VS XL 390 x 80	Single	7-1/2	> 0.42	12,400	
			> 0.50	15,000	

Notes:

1. Tabulated weld values are minimum requirements. Additional weld size or length may be required dependent on loading conditions. Welded connections must be designed by a licensed professional engineer.
2. Primary member steel must have a thickness of at least 1/4 in.
3. Welds must conform to the current AWS D1.1 Structural Welding Code—Steel. Follow proper welding procedures and safety precautions.
4. Welds must be symmetrical on each side of the hanger and be centered within the height of the hanger.
5. Welded connections are not compatible with the Clip Lock system and are therefore not recommended for uplift conditions.
6. The RICON S VS can be welded directly to structural steel elements such as steel columns and steel embed plates in concrete walls.
7. The galvanized coating must be ground off the areas to be welded.



Steel-to-Wood Connection

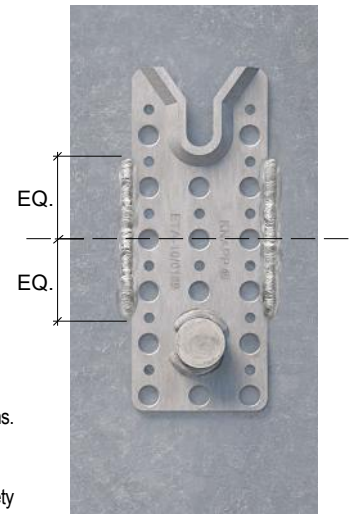

Welded RICON S VS Connection

RICON S VS Clip Lock

Clip Lock Brace System for Uplift

Clip Lock brace systems are additional components available for the RICON S VS beam hanger system. The Clip Lock is a special thin steel plate designed to fit into and lock the RICON S VS beam hanger plates together, yielding a resistance to uplift forces. The Clip Lock is installed with the hanger on the primary beam or column, and as the secondary beam is lowered into place, the Clip Lock will automatically engage the screw heads on the opposite plate, providing resistance to uplift loads. These components are installed using the same screws used to fasten the beam hanger plates into the wood member. A new screw pattern applies to the primary member to allow the Clip Lock to be installed properly, which results in a reduced download capacity. Screws cannot be installed at the prohibited screw locations as they will deform the Clip Lock and prevent it from working properly.

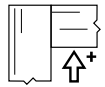
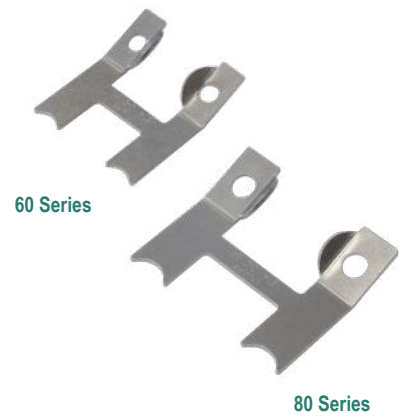

Uplift Force Resistance

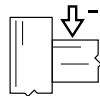

Reduced Downward Force



Table 2.4 - Screw Patterns with Clip Lock Brace System (in Primary Member)

- Clip Lock Mounting Screw Locations
- Prohibited Screw Locations



	RICON S VS 140 x 60	RICON S VS 200 x 60	RICON S VS 200 x 80	RICON S VS 290 x 80	RICON S VS XL 390 x 80
VG CSK Screw Qty.	7	13	13	17	28

Note:

1. Secondary member is assumed to have fasteners installed as noted in Table 2.1.

RICON S VS 60 Series - Geometry Requirements

RICON S VS 60 Series - Connector Geometry

Table 2.5 - RICON S VS 60 Geometry

Connector Geometry	Model	
	RICON S VS 140 x 60	RICON S VS 200 x 60
	[in.]	
H	5-1/2	7-7/8
W	2-3/8	2-3/8
T	31/32	31/32

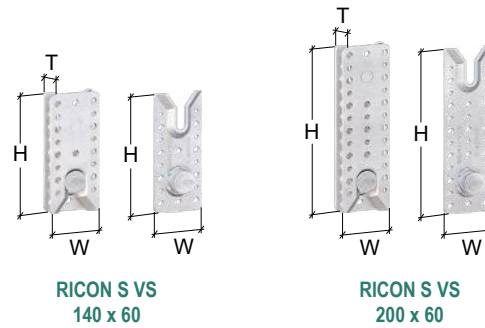

Note:

1. Refer to Appendix D: Product Specifications (Page 109) for additional product specifications.

Secondary Member Geometry Requirements

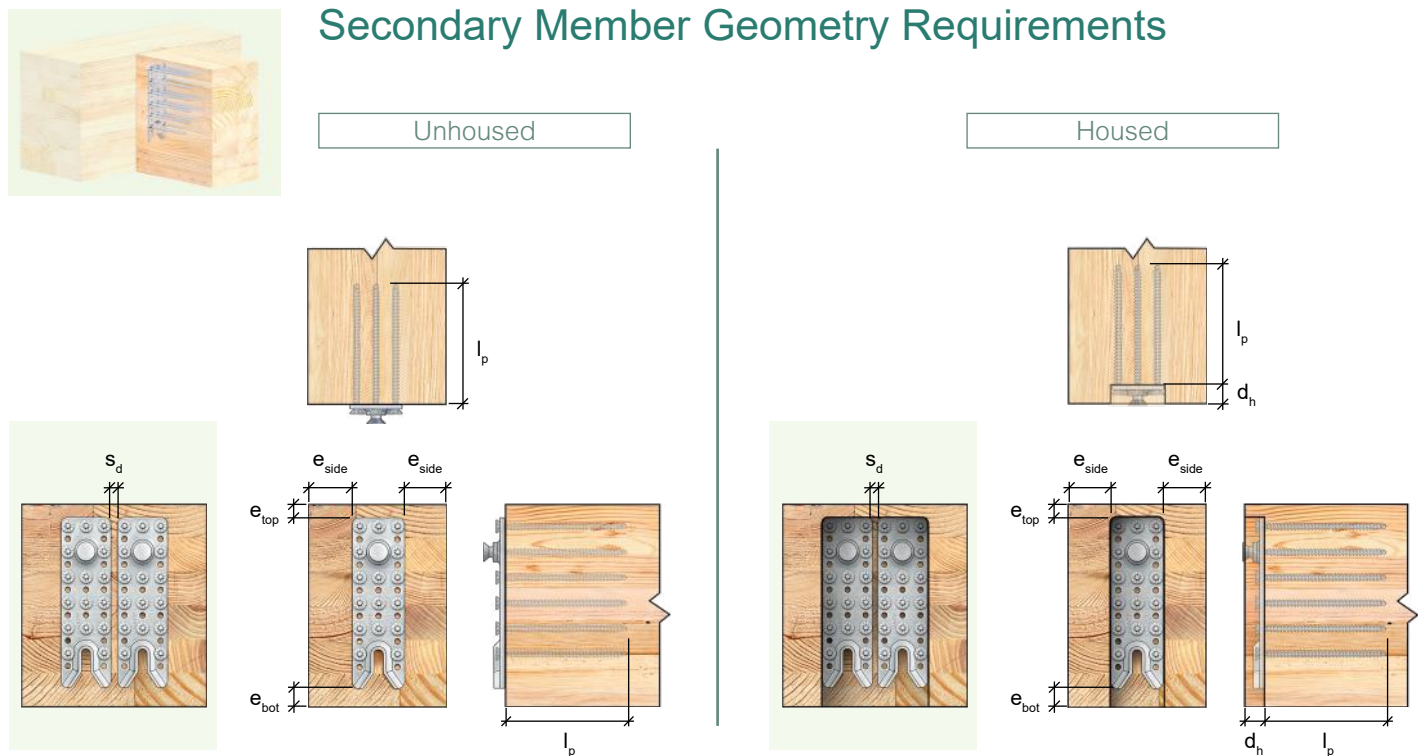

Table 2.6 - RICON S VS 60 Geometry Requirements for Secondary Member

RICON S VS 60		Geometry Requirements [in.]									
Model	Configuration	l_p	e_{top}	No FRR		1-hr FRR		2-hr FRR		d_h	s_d
				e_{side}	e_{bot}	e_{side}	e_{bot}	e_{side}	e_{bot}		
RICON S VS 140 x 60	Single	5-31/32	1-13/16	5/8	0	1-23/32	2-1/32	3	3-3/4	15/16	N/A
	Double	5-31/32	1-13/16	5/8	0	1-23/32	2-1/32	3	3-3/4	15/16	5/16
RICON S VS 200 x 60	Single	5-31/32	1-13/16	5/8	0	1-23/32	2-1/32	3	3-3/4	15/16	N/A
	Double	5-31/32	1-13/16	5/8	0	1-23/32	2-1/32	3	3-3/4	15/16	5/16

Notes:

1. Connection design must meet all relevant requirements of the General Notes to the Designer section.
2. Screw installation must follow the patterns presented in the Installation section.
3. Tabulated values presented are the minimum required unless noted otherwise. Tabulated values for l_p are fixed. Tabulated values for d_h are maximum values based on a gap between primary and secondary member of 0.039 in. Larger gaps (such as a typical gap of 1/8 in.) will reduce d_h accordingly.
4. Tabulated values that are not dependent on FRR, as well as those for secondary beams with no FRR, are based on minimum end and edge distances.
5. Minimum dimensions for beams with an FRR are based on minimum wood cover requirements specified in NDS 2024 Chapter 16.5. Beam sizes satisfying an FRR assume a fire-resistant joint compliant with FDS 2024 Section 2.5.1.3. and that any void below the connector in the routing has been sealed with a wood plug.

Primary Member Geometry Requirements - Beam/Girder



Unhoused

Housed

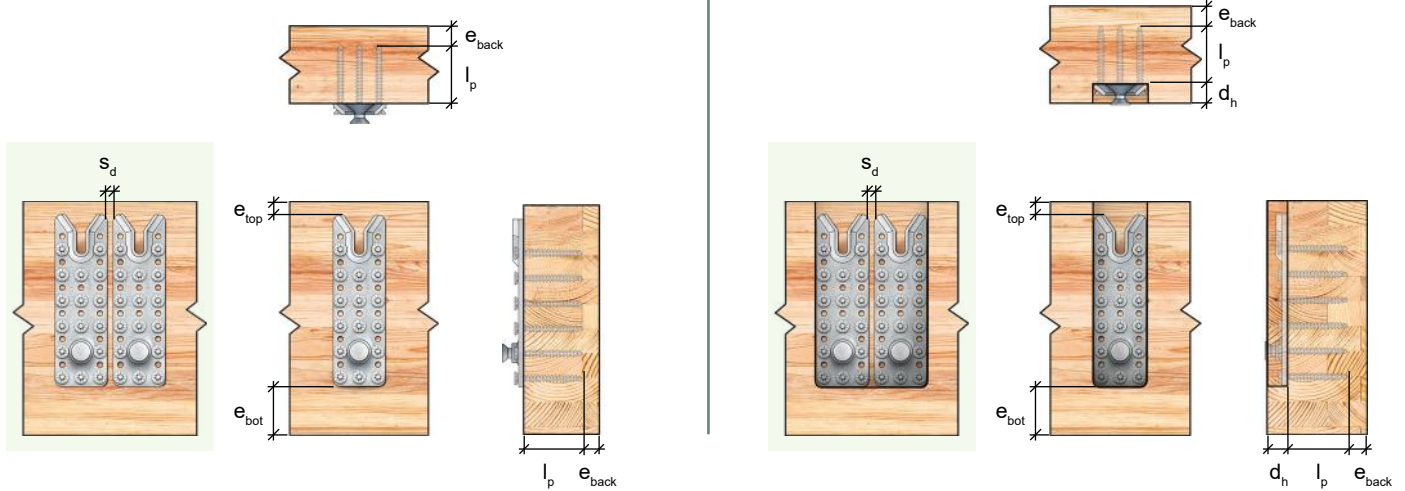

Table 2.7 - RICON S VS 60 Geometry Requirements for Primary Member (Beam/Girder)

RICON S VS 60		Geometry Requirements [in.]									
		l _p	e _{top}	No FRR		1-hr FRR		2-hr FRR		d _h	s _d
				e _{bot}	e _{back}	e _{bot}	e _{back}	e _{bot}	e _{back}		
RICON S VS 140 x 60	Single	2-27/32	1-13/16	1-13/16	13/32	2-1/32	1-23/32	3-3/4	3	15/16	N/A
	Double	2-27/32	1-13/16	1-13/16	13/32	2-1/32	1-23/32	3-3/4	3	15/16	5/16
RICON S VS 200 x 60	Single	2-27/32	1-13/16	1-13/16	13/32	2-1/32	1-23/32	3-3/4	3	15/16	N/A
	Double	2-27/32	1-13/16	1-13/16	13/32	2-1/32	1-23/32	3-3/4	3	15/16	5/16

Notes:

1. Connection design must meet all relevant requirements of the General Notes to the Designer section.
2. Screw installation must follow the patterns presented in the Installation section.
3. Tabulated values presented are the minimum required unless noted otherwise. Tabulated values for l_p are fixed. Tabulated values for d_h are maximum values based on a gap between primary and secondary member of 0.039 in. Larger gaps (such as a typical gap of 1/8 in.) will reduce d_h accordingly.
4. Tabulated values that are not dependent on FRR, as well as those for primary beams with no FRR, are based on minimum end and edge distances.
5. Minimum dimensions for beams with an FRR are based on minimum wood cover requirements specified in NDS 2024 Chapter 16.5. Beam sizes satisfying an FRR assume a fire-resistant joint compliant with FDS 2024 Section 2.5.1.3. and that any void below the connector in the routing has been sealed with a wood plug.
6. Values for e_{top} are minimum requirements based on minimum end and edge distance, and may need to be adjusted to align with the hanger placement in the secondary beam.

Primary Member Geometry Requirements - Column



Unhoused

Housed

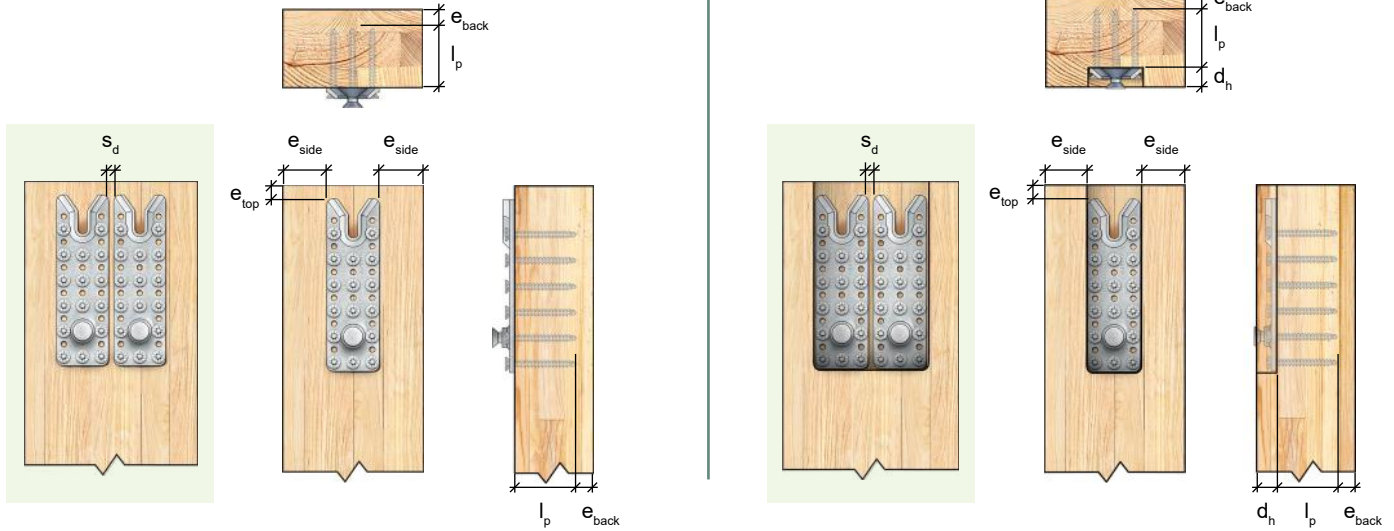

Table 2.8 - RICON S VS 60 Geometry Requirements for Primary Member (Column)

RICON S VS 60		Geometry Requirements [in.]									
		l_p	e_{top}	No FRR		1-hr FRR		2-hr FRR		d_h	s_d
e_{side}	e_{back}			e_{side}	e_{back}	e_{side}	e_{back}				
RICON S VS 140 x 60	Single	2-27/32	1-13/16	5/8	13/32	1-23/32	1-23/32	3	3	15/16	N/A
	Double	2-27/32	1-13/16	5/8	13/32	1-23/32	1-23/32	3	3	15/16	5/16
RICON S VS 200 x 60	Single	2-27/32	1-13/16	5/8	13/32	1-23/32	1-23/32	3	3	15/16	N/A
	Double	2-27/32	1-13/16	5/8	13/32	1-23/32	1-23/32	3	3	15/16	5/16

Notes:

1. Connection design must meet all relevant requirements of the General Notes to the Designer section.
2. Screw installation must follow the patterns presented in the Installation section.
3. Tabulated values presented are the minimum required unless noted otherwise. Tabulated values for l_p are fixed. Tabulated values for d_h are maximum values based on a gap between primary and secondary member of 0.039 in. Larger gaps (such as a typical gap of 1/8 in.) will reduce d_h accordingly.
4. Tabulated values that are not dependent on FRR, as well as those for columns with no FRR, are based on minimum end and edge distances.
5. Minimum dimensions for columns with an FRR are based on connection minimum wood cover requirements specified in NDS 2024 Chapter 16.5. Column sizes satisfying an FRR assume a fire-resistant joint compliant with FDS 2024 Section 2.5.1.3, and that any void below the connector in the routing has been sealed with a wood plug.
6. Values for e_{top} are minimum requirements based on minimum end and edge distance, and may need to be adjusted to align with the hanger placement in the secondary beam.

RICON S VS 80 Series - Geometry Requirements

RICON S VS 80 Series - Connector Geometry

Table 2.9 - RICON S VS 80 Geometry

Connector Geometry	Model	
	RICON S VS 200 x 80	RICON S VS 290 x 80
[in.]		
H	7-7/8	11-13/32
W	3-5/32	3-5/32
T	31/32	31/32

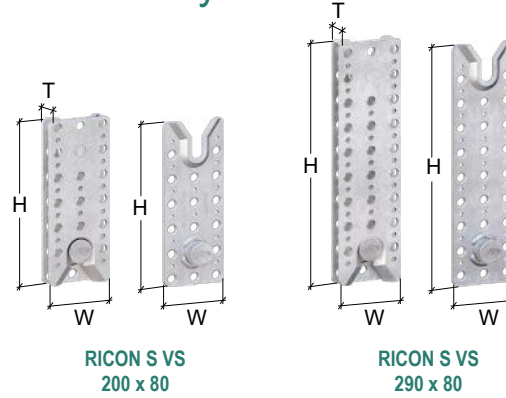

Note:

1. Refer to Appendix D: Product Specifications (Page 109) for additional product specifications.



Secondary Member Geometry Requirements

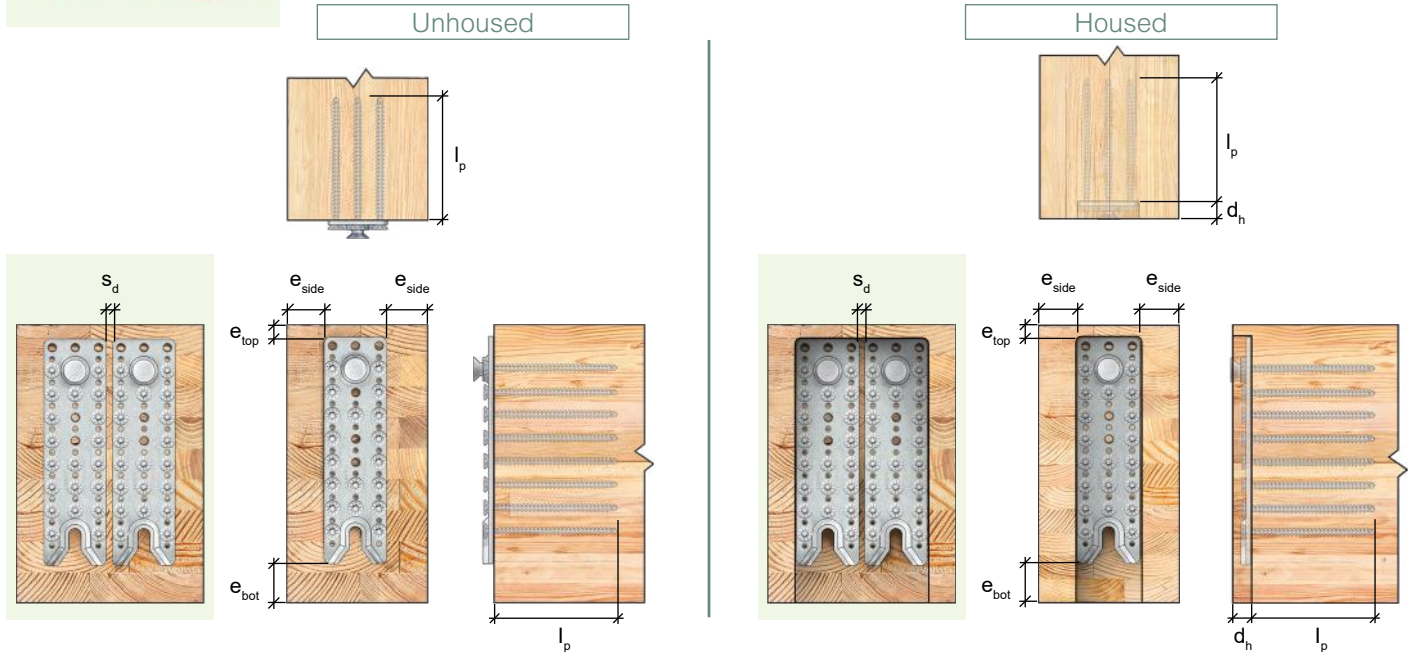

Table 2.10 - RICON S VS 80 Geometry Requirements for Secondary Member

RICON S VS 80		Geometry Requirements [in.]									
Model	Configuration	l_p	e_{top}	No FRR		1-hr FRR		2-hr FRR		d_h	s_d
				e_{side}	e_{bot}	e_{side}	e_{bot}	e_{side}	e_{bot}		
RICON S VS 200 x 80	Single	7-9/16	2-3/8	25/32	0	1-23/32	2-1/32	3	3-3/4	15/16	N/A
	Double	7-9/16	2-3/8	25/32	0	1-23/32	2-1/32	3	3-3/4	15/16	13/32
RICON S VS 290 x 80	Single	7-9/16	1-3/16	25/32	0	1-23/32	2-1/32	3	3-3/4	15/16	N/A
	Double	7-9/16	1-3/16	25/32	0	1-23/32	2-1/32	3	3-3/4	15/16	13/32

Notes:

1. Connection design must meet all relevant requirements of the General Notes to the Designer section.
2. Screw installation must follow the patterns presented in the Installation section.
3. Tabulated values presented are the minimum required unless noted otherwise. Tabulated values for l_p are fixed. Tabulated values for d_h are maximum values based on a gap between primary and secondary member of 0.039 in. Larger gaps (such as a typical gap of 1/8 in.) will reduce d_h accordingly.
4. Tabulated values that are not dependent on FRR, as well as those for secondary beams with no FRR, are based on minimum end and edge distances.
5. Minimum dimensions for beams with an FRR are based on minimum wood cover requirements specified in NDS 2024 Chapter 16.5. Beam sizes satisfying an FRR assume a fire-resistant joint compliant with FDS 2024 Section 2.5.1.3. and that any void below the connector in the routing has been sealed with a wood plug.

Primary Member Geometry Requirements - Beam/Girder



Unhoused

Housed

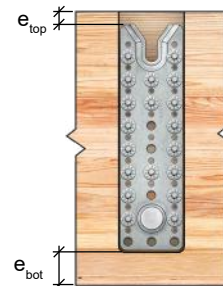
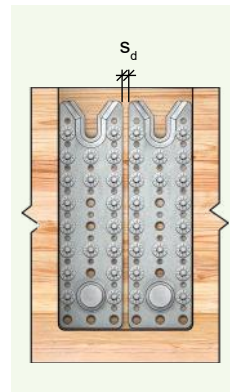
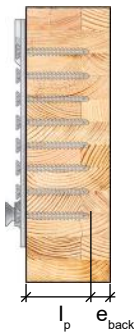
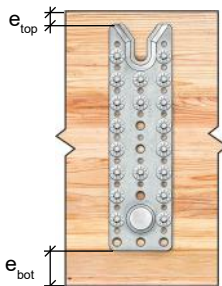
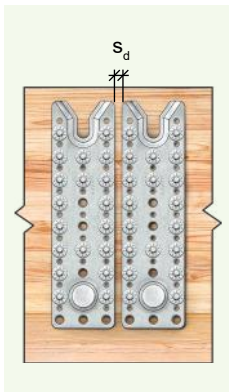
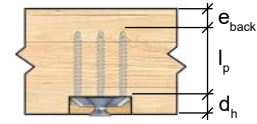
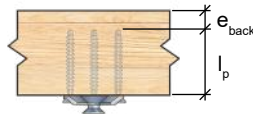

Table 2.11 - RICON S VS 80 Geometry Requirements for Primary Member (Beam/Girder)

RICON S VS 80		Geometry Requirements [in.]									
		l_p	e_{top}	No FRR		1-hr FRR		2-hr FRR		d_h	s_d
e_{bot}	e_{back}			e_{bot}	e_{back}	e_{bot}	e_{back}				
RICON S VS 200 x 80	Single	3-5/8	2-3/8	2-3/8	13/32	2-3/8	1-23/32	3-3/4	3	15/16	N/A
	Double	3-5/8	2-3/8	2-3/8	13/32	2-3/8	1-23/32	3-3/4	3	15/16	13/32
RICON S VS 290 x 80	Single	3-5/8	1-3/16	1-3/16	13/32	2-1/32	1-23/32	3-3/4	3	15/16	N/A
	Double	3-5/8	1-3/16	1-3/16	13/32	2-1/32	1-23/32	3-3/4	3	15/16	13/32

Notes:

1. Connection design must meet all relevant requirements of the General Notes to the Designer section.
2. Screw installation must follow the patterns presented in the Installation section.
3. Tabulated values presented are the minimum required unless noted otherwise. Tabulated values for l_p are fixed. Tabulated values for d_h are maximum values based on a gap between primary and secondary member of 0.039 in. Larger gaps (such as a typical gap of 1/8 in.) will reduce d_h accordingly.
4. Tabulated values that are not dependent on FRR, as well as those for primary beams with no FRR, are based on minimum end and edge distances.
5. Minimum dimensions for beams with an FRR are based on minimum wood cover requirements specified in NDS 2024 Chapter 16.5. Beam sizes satisfying an FRR assume a fire-resistant joint compliant with FDS 2024 Section 2.5.1.3. and that any void below the connector in the routing has been sealed with a wood plug.
6. Values for e_{top} are minimum requirements based on minimum end and edge distance, and may need to be adjusted to align with the hanger placement in the secondary beam.

Primary Member Geometry Requirements - Column



Unhoused

Housed

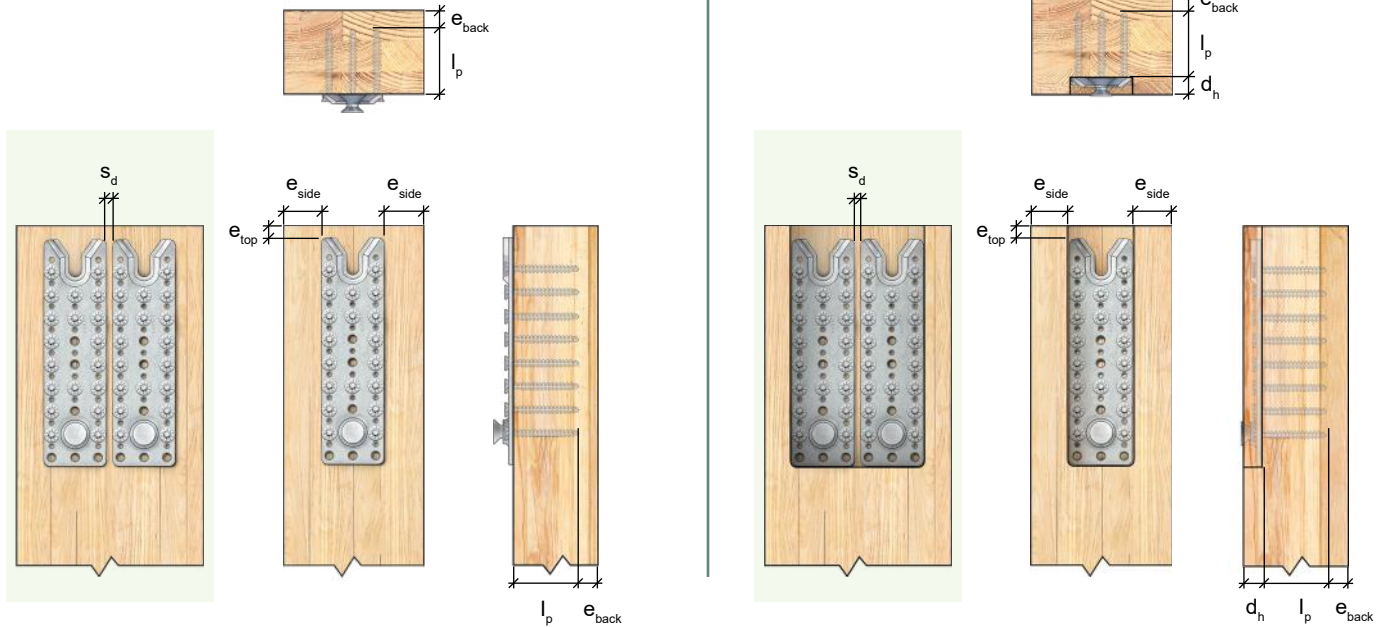

Table 2.12 - RICON S VS 80 Geometry Requirements for Primary Member (Column)

RICON S VS 80		Geometry Requirements [in.]									
		l_p	e_{top}	No FRR		1-hr FRR		2-hr FRR		d_h	s_d
e_{side}	e_{back}			e_{side}	e_{back}	e_{side}	e_{back}				
RICON S VS 200 x 80	Single	3-5/8	2-3/8	25/32	13/32	1-23/32	1-23/32	3	3	15/16	N/A
	Double	3-5/8	2-3/8	25/32	13/32	1-23/32	1-23/32	3	3	15/16	13/32
RICON S VS 290 x 80	Single	3-5/8	1-3/16	25/32	13/32	1-23/32	1-23/32	3	3	15/16	N/A
	Double	3-5/8	1-3/16	25/32	13/32	1-23/32	1-23/32	3	3	15/16	13/32

Notes:

1. Connection design must meet all relevant requirements of the General Notes to the Designer section.
2. Screw installation must follow the patterns presented in the Installation section.
3. Tabulated values presented are the minimum required unless noted otherwise. Tabulated values for l_p are fixed. Tabulated values for d_h are maximum values based on a gap between primary and secondary member of 0.039 in. Larger gaps (such as a typical gap of 1/8 in.) will reduce d_h accordingly.
4. Tabulated values that are not dependent on FRR, as well as those for columns with no FRR, are based on minimum end and edge distances.
5. Minimum dimensions for columns with an FRR are based on connection minimum wood cover requirements specified in NDS 2024 Chapter 16.5. Column sizes satisfying an FRR assume a fire-resistant joint compliant with FDS 2024 Section 2.5.1.3. and that any void below the connector in the routing has been sealed with a wood plug.
6. Values for e_{top} are minimum requirements based on minimum end and edge distance, and may need to be adjusted to align with the hanger placement in the secondary beam.

RICON S VS XL - Geometry Requirements

RICON S VS XL - Connector Geometry

Table 2.13 - RICON S VS XL Geometry

Connector Geometry	Model
	RICON S VS XL 390 x 80 [in.]
H_1	13-3/8
H_2	15-11/32
T	31/32
W	3-5/32

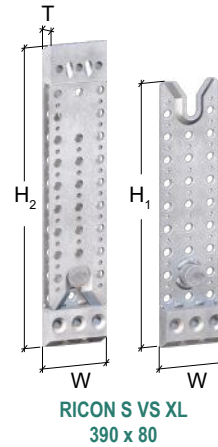

Note:

1. Refer to Appendix D: Product Specifications (Page 109) for additional product specifications.



Secondary Member Geometry Requirements

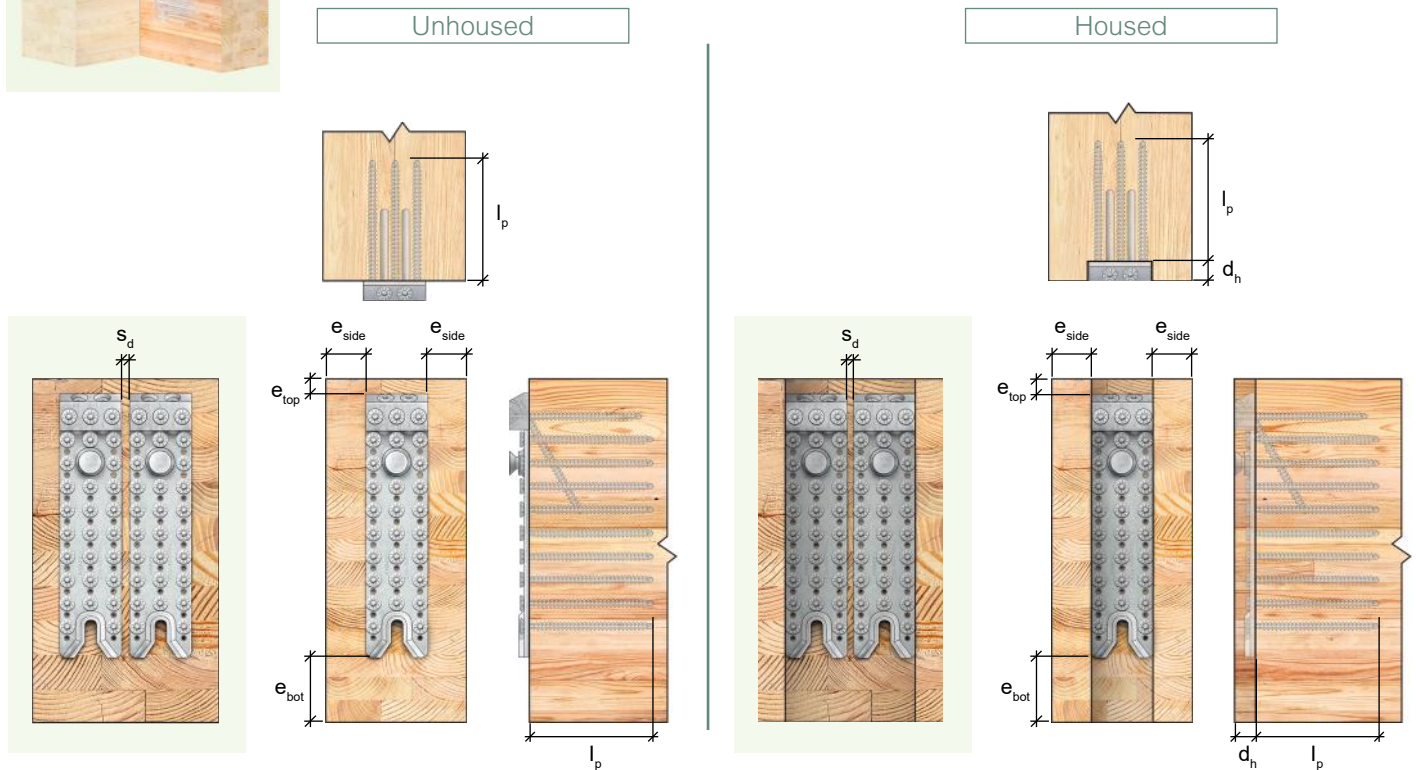

Table 2.14 - RICON S VS XL 390 x 80 Geometry Requirements for Secondary Member

RICON S VS XL		Geometry Requirements [in.]									
Model	Configuration	l_p	e_{top}	No FRR		1-hr FRR		2-hr FRR		d_h	s_d
				e_{side}	e_{bot}	e_{side}	e_{bot}	e_{side}	e_{bot}		
RICON S VS XL 390 x 80	Single	7-9/16	1-9/16	25/32	1-31/32	1-23/32	4-7/32	3	5-29/32	15/16	N/A
	Double	7-9/16	1-9/16	25/32	1-31/32	1-23/32	4-7/32	3	5-29/32	15/16	13/32

Notes:

1. Connection design must meet all relevant requirements of the General Notes to the Designer section.
2. Screw installation must follow the patterns presented in the Installation section.
3. Tabulated values presented are the minimum required unless noted otherwise. Tabulated values for l_p are fixed. Tabulated values for d_h are maximum values based on a gap between primary and secondary member of 0.039 in. Larger gaps (such as a typical gap of 1/8 in.) will reduce d_h accordingly.
4. Tabulated values that are not dependent on FRR, as well as those for secondary beams with no FRR, are based on minimum end and edge distances.
5. Minimum dimensions for beams with an FRR are based on minimum wood cover requirements specified in NDS 2024 Chapter 16.5. Beam sizes satisfying an FRR assume a fire-resistant joint compliant with FDS 2024 Section 2.5.1.3. and that any void below the connector in the routing has been sealed with a wood plug.

Primary Member Geometry Requirements - Beam/Girder



Unhoused

Housed

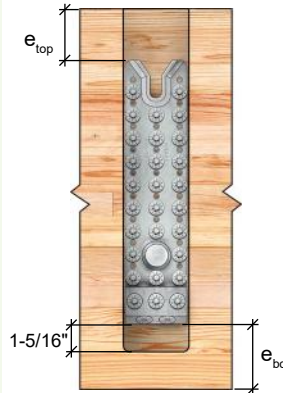
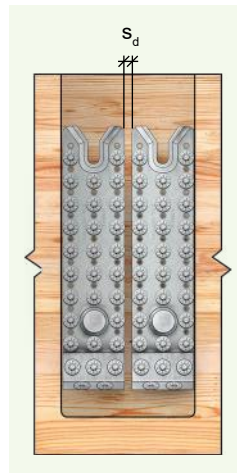
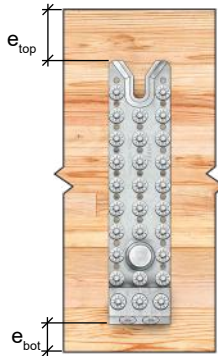
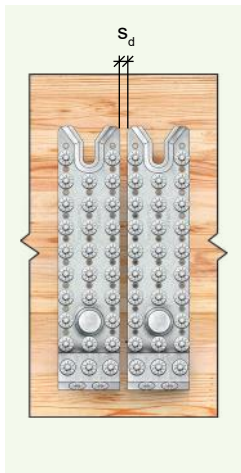
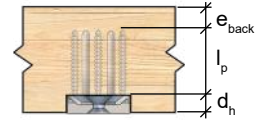
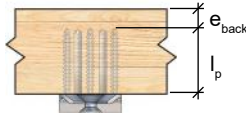

Table 2.15 - RICON S VS XL 390 x 80 Geometry Requirements for Primary Member (Beam/Girder)

RICON S VS XL		Geometry Requirements [in.]									
		l_p	e_{top}	No FRR		1-hr FRR		2-hr FRR		d_h	s_d
e_{bot}	e_{back}			e_{bot}	e_{back}	e_{bot}	e_{back}				
RICON S VS XL 390 x 80	Single	3-5/8	3-17/32	1-9/16	13/32	2-1/4	1-23/32	3-15/16	3	15/16	N/A
	Double	3-5/8	3-17/32	1-9/16	13/32	2-1/4	1-23/32	3-15/16	3	15/16	13/32

Notes:

1. Connection design must meet all relevant requirements of the General Notes to the Designer section.
2. Screw installation must follow the patterns presented in the Installation section.
3. Tabulated values presented are the minimum required unless noted otherwise. Tabulated values for l_p are fixed. Tabulated values for d_h are maximum values based on a gap between primary and secondary member of 0.039 in. Larger gaps (such as a typical gap of 1/8 in.) will reduce d_h accordingly.
4. Tabulated values that are not dependent on FRR, as well as those for primary beams with no FRR, are based on minimum end and edge distances.
5. Minimum dimensions for beams with an FRR are based on minimum wood cover requirements specified in NDS 2024 Chapter 16.5. Beam sizes satisfying an FRR assume a fire-resistant joint compliant with FDS 2024 Section 2.5.1.3. and that any void below the connector in the routing has been sealed with a wood plug.
6. Values for e_{top} are minimum requirements based on minimum end and edge distance, and may need to be adjusted to align with the hanger placement in the secondary beam.
7. For any connection with an FRR where the RICON S VS XL is housed in the primary beam, the space below the RICON S VS XL must be filled with noncombustible material.

Primary Member Geometry Requirements - Column



Unhoused

Housed

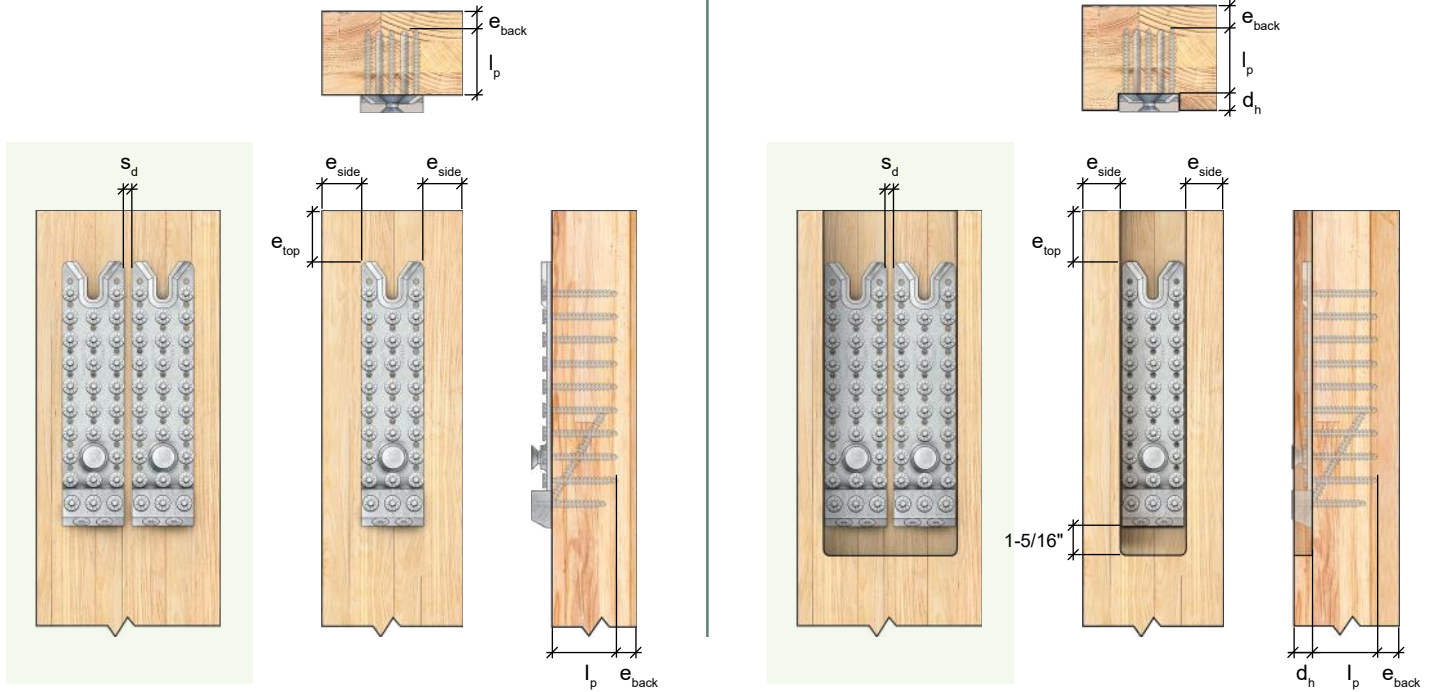

Table 2.16 - RICON S VS XL 390 x 80 Geometry Requirements for Primary Member (Column)

RICON S VS XL		Geometry Requirements [in.]									
		l_p	e_{top}	No FRR		1-hr FRR		2-hr FRR		d_h	s_d
e_{side}	e_{back}			e_{side}	e_{back}	e_{side}	e_{back}				
RICON S VS XL 390 x 80	Single	3-5/8	3-17/32	25/32	13/32	1-23/32	1-23/32	3	3	15/16	N/A
	Double	3-5/8	3-17/32	25/32	13/32	1-23/32	1-23/32	3	3	15/16	13/32

Notes:

1. Connection design must meet all relevant requirements of the General Notes to the Designer section.
2. Screw installation must follow the patterns presented in the Installation section.
3. Tabulated values presented are the minimum required unless noted otherwise. Tabulated values for l_p are fixed. Tabulated values for d_h are maximum values based on a gap between primary and secondary member of 0.039 in. Larger gaps (such as a typical gap of 1/8 in.) will reduce d_h accordingly.
4. Tabulated values that are not dependent on FRR, as well as those for columns with no FRR, are based on minimum end and edge distances.
5. Minimum dimensions for columns with an FRR are based on connection minimum wood cover requirements specified in NDS 2024 Chapter 16.5. Column sizes satisfying an FRR assume a fire-resistant joint compliant with FDS 2024 Section 2.5.1.3. and that any void below the connector in the routing has been sealed with a wood plug.
6. Values for e_{top} are minimum requirements based on minimum end and edge distance, and may need to be adjusted to align with the hanger placement in the secondary beam.
7. For any connection with an FRR where the RICON S VS XL is housed in the column, the space below the RICON S VS XL must be filled with noncombustible material.

Additional Detailing Considerations

Geometry Requirements for Columns with Multiple Beam Hangers

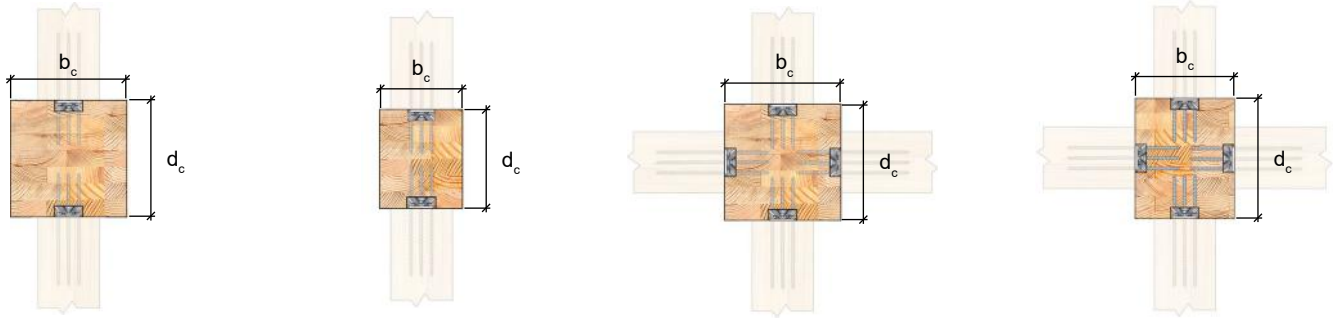

Hangers on Opposing Faces of a Square Column

Hangers on Opposing Faces of a Rectangular Column

Hanger on Each Face of a Square Column

Hanger on Each Face of a Rectangular Column

Table 2.17 - Minimum Column Sizes for Multiple RICON S VS Connectors

Model Series	Minimum Column Section Dimensions, $b_c \times d_c$ [in. x in.]					
	Hangers on Opposing Faces of a Square Column			Hangers on Opposing Faces of a Rectangular Column		
	No FRR	1-hr FRR	2-hr FRR	No FRR	1-hr FRR	2-hr FRR
RICON S VS 60	8-1/16 x 8-1/16	8-1/16 x 8-1/16	8-3/8 x 8-3/8	3-5/8 x 8-1/16	5-25/32 x 8-1/16	8-3/8 x 8-1/16
RICON S VS 80 and XL	9-5/8 x 9-5/8	9-5/8 x 9-5/8	9-5/8 x 9-5/8	4-23/32 x 9-5/8	6-9/16 x 9-5/8	9-5/32 x 9-5/8

Model Series	Minimum Column Section Dimensions, $b_c \times d_c$ [in. x in.]					
	Hanger on Each Face of a Square Column			Hangers on Each Face of a Rectangular Column		
	No FRR	1-hr FRR	2-hr FRR	No FRR	1-hr FRR	2-hr FRR
RICON S VS 60	10 x 10	10 x 10	10 x 10	8-1/16 x 10-19/32	8-1/16 x 10-19/32	8-3/8 x 10-19/32
RICON S VS 80 and XL	12-7/32 x 12-7/32	12-7/32 x 12-7/32	12-7/32 x 12-7/32	9-5/8 x 12-7/8	9-5/8 x 12-7/8	9-5/8 x 12-7/8

Notes:

1. Tabulated column section dimensions are minimum values based on a 1/2 in. clearance between screw tips, minimum edge and end distances, and minimum wood cover requirements for FRR. Refer to Geometry Requirements for further details.
2. It is the responsibility of the EOR to ensure the primary and secondary members have adequate capacity to resist connection forces.
3. Tabulated column section dimensions assume hangers are centered within each column face and are housed in the column as shown.

Hanger Placement Considerations

The hanger placement relative to the height of the beam can impact the need for reinforcement. Connectors in the primary member should have the uppermost fastener in the top 30% of the member depth (0.3d), as shown in the bottom left figure. Connectors in the secondary member should have the lowermost fastener in the bottom 20% (0.2d), as shown in the bottom right figure. Outside of these zones, the primary and secondary members should be checked for splitting to determine if reinforcement is required. For further information, refer to Appendix C: Survey of Literature on Reinforcement for Tension Perpendicular to Grain (Page 100).

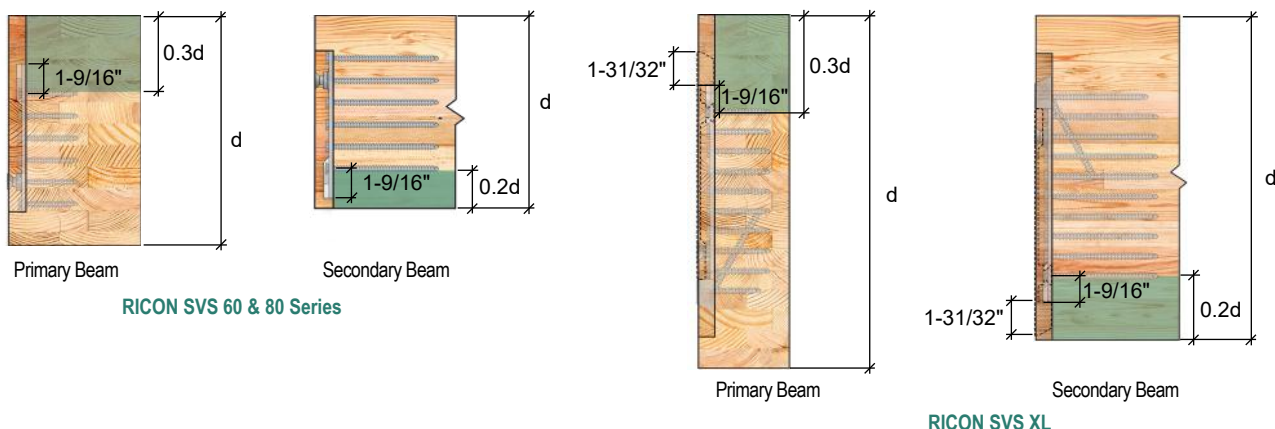

Primary Beam

Secondary Beam

RICON SVS 60 & 80 Series

Primary Beam

Secondary Beam

RICON SVS XL

Skewed and Sloped Configurations

RICON S VS connectors can be installed in sloped or skewed configurations. These configurations may require different fastener lengths for the connector plate installed into the secondary member to prevent the fasteners from protruding at a steep angle. The connector plate installed into the primary member (e.g., girder beam or a column) has fasteners driven in the side grain. Because this fiber orientation promotes higher withdrawal capacity, the fasteners may be shorter and still sustain the same load. In a typical installation configuration, the connector plate installed into the secondary member has fasteners driven into the end grain. Longer fully threaded screws are used in the secondary member in order to compensate for the reduced withdrawal capacity characteristic of this orientation of the wood fiber.



Sloped Configuration: Rafter-to-Ridge Beam Connection



Skewed Configuration: Joist-to-Beam Connection

In sloped and skewed connections, the connector plate installed into the secondary member has fasteners driven into the grain at an angle relative to the connection angle. The connection benefits from changing the angle-to-grain relationship, and thus respective design values may be achieved with shorter screw lengths in the secondary member.

Sloped and Skewed Connection Requirements

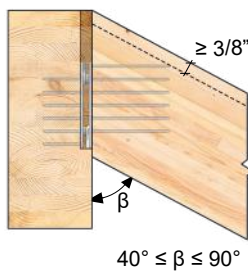

Sloped Configuration: Rafter-to-Ridge Beam Connection (Side View)

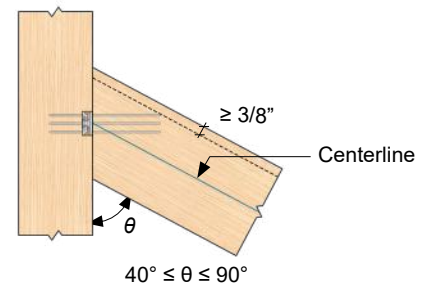

Skewed Configuration: Joist-to-Beam or Column Connection (Top View)

In sloped and skewed connections, the connector placement must adhere to the connection geometry requirements in order to avoid reinforcement. Where connection geometry imposes restrictions, fastener length may be reduced, and allowable connection loads shall be adjusted with the appropriate reduction factor, R_s . For skewed connections ($40^\circ \leq \theta \leq 90^\circ$), the connector must be aligned with the centerline of the joist; otherwise, eccentricities and resulting moments must be accounted for by the Engineer of Record.

Table 2.18 - Reduction Factor, R_s , for RICON S VS 60 Series

Fastener Length [in.]	β or $\theta = 90^\circ$	β or $\theta = 80^\circ$	β or $\theta = 70^\circ$	β or $\theta = 60^\circ$	β or $\theta = 50^\circ$	β or $\theta = 40^\circ$
6-1/4	1.0	1.0	1.0	1.0	1.0	1.0
5-1/2	0.9	1.0	1.0	1.0	1.0	1.0
4-3/4	0.8	0.9	0.9	1.0	1.0	1.0

1. Reduced fastener lengths only apply for installation in the secondary member.
2. Allowable load of the connector must be adjusted with the reduction factor provided in the table.
3. Reduction factor values are derived from ETA-10/0189.

Table 2.19 - Reduction Factor, R_s , for RICON S VS 80 Series and RICON S VS XL

Fastener Length [in.]	β or $\theta = 90^\circ$	β or $\theta = 80^\circ$	β or $\theta = 70^\circ$	β or $\theta = 60^\circ$	β or $\theta = 50^\circ$	β or $\theta = 40^\circ$
7-7/8	1.0	1.0	1.0	1.0	1.0	1.0
7-1/8	0.9	1.0	1.0	1.0	1.0	1.0
6-1/4	0.8	0.9	0.9	1.0	1.0	1.0
5-1/2	0.7	0.8	0.8	0.9	0.9	1.0

Note: Refer to the notes below Table 2.18.

Housing Details

Housing Possibilities

Primary Beam Housing

- Most common housing for concealed installation
- Concealed from below

Secondary Beam Housing

- Joist housing from bottom up
- Concealed from below with a wood plug

Secondary Beam Through Housing

- Full-depth housing in joist
- Concealed from below with a wood plug
- Simplifies fabrication



Housing and Surface Detailing



Surface-Mounted



Housed in Primary Member
(Column)



Housed in Primary Member
(Girder)



Housed in Secondary Member
(Joist or Purlin)

Parallel Surface: The members must be parallel at the location of the connection to ensure proper hanger alignment and load transfer.

Gap Size: The gap size between wood members balances installation ease and fire performance, with larger gaps simplifying installation but reducing fire protection. The gap is typically sized at 1/8 in. [3.2 mm] to address fire protection considerations as outlined in FDS 2024 [refer to Appendix A: Fire Protection (Page 92)]. For proper installation, a minimum gap of 0.039 in. [1 mm] is required to allow the secondary member to slide into place.

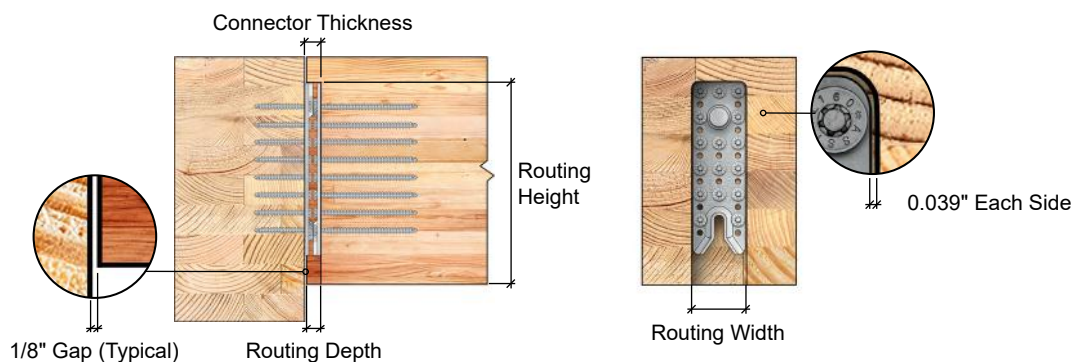

Routing Depth: The routing depth is the depth of the housing, d_n , noted in the Geometry Requirements and Routing Details sections. This depth takes into account the thickness of the connector and the gap between members (assumed as 0.039 in. [1 mm] herein - larger gaps will reduce d_n accordingly).

Routing Width: It is recommended to allow a clearance of 0.039 in. [1 mm] on each side of the connector:

- RICON S VS 60 Series: 2.441 in. [62 mm]
- RICON S VS 80 Series (including RICON S VS XL): 3.228 in. [82 mm]

Routing Height: The routing height must be coordinated with the Engineer of Record. The height of the connector in the beam section has an impact on connector performance. Refer to Hanger Placement Considerations (Page 47) for further information.

Housing Dimensions

Routing in Primary Member

Fastener Orientation
 Structural Positioning Screws
 (Refer to Fastener Layout on Page 53)

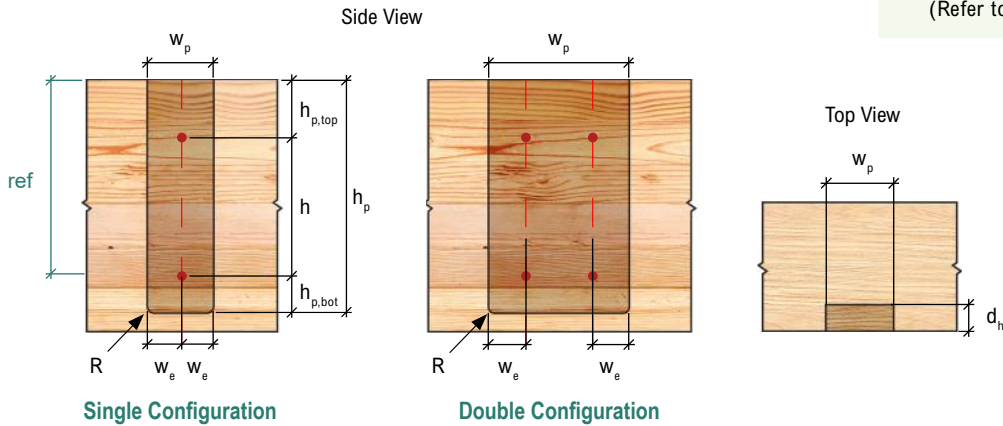

Table 2.20 - Routing Dimensions for RICON S VS Housed in Primary Member

Model	Routing Dimensions, in. [mm]								
	h_p	$h_{p,top}$	h	$h_{p,bot}$	w_p		w_e	d_h	R
					Single	Double			
RICON S VS 140 x 60	7.362 [187]	4.567 [116]	3.543 [90]	0.433 [11]	2.441 [62]	5.118 [130]	1.220 [31]	0.945 [24]	0.295 [7.5]
RICON S VS 200 x 60	9.724 [247]	4.567 [116]	4.724 [120]	0.433 [11]	2.441 [62]	5.118 [130]	1.220 [31]	0.945 [24]	0.295 [7.5]
RICON S VS 200 x 80	10.276 [261]	5.118 [130]	4.724 [120]	0.433 [11]	3.228 [82]	6.772 [172]	1.614 [41]	0.945 [24]	0.295 [7.5]
RICON S VS 290 x 80	13.638 [321]	3.937 [100]	5.906 [150]	0.433 [11]	3.228 [82]	6.772 [172]	1.614 [41]	0.945 [24]	0.295 [7.5]
RICON S VS XL 390 x 80	20.197 [513]	6.299 [160]	8.268 [210]	5.630 [160]	3.228 [82]	6.772 [172]	1.614 [41]	0.945 [24]	0.295 [7.5]

Notes:

1. Tabulated values are general guidelines for routing requirements. The EOR and fabricator are responsible for ensuring final routing dimensions account for all project-specific conditions.
2. Tabulated values are minimum requirements unless noted otherwise. Tabulated values for h and R are fixed. Tabulated values for d_h are maximum allowable.
3. Tabulated values account for 0.039 in. [1 mm] on each side of and below the hanger. Larger installation tolerances will increase height and width values accordingly.
4. Tabulated values are based on a gap of 0.039 in. [1 mm] between the primary and secondary member. Larger gaps (such as a typical gap of 1/8 in.) will reduce d_h accordingly.
5. Refer to the Geometry Requirements tables for each respective beam hanger for additional information.
6. Tabulated values for h_p and $h_{p,bot}$ for the RICON S VS XL account for a 1-5/16 in. [33.0 mm] gap below the connector to allow the installation of the fasteners. The resulting hidden void should be protected from fire using industry-approved methods.
7. Manufacturers should adjust the tabulated values based on their specific routing bit sizes if different than R .

RICON S VS XL - Additional Routing Clearance Requirements

An additional housing clearance of 1-5/16 in. [32 mm] must be accounted for during design phase for the 45° inclined screws of the RICON S VS XL.

Notes:

1. A bit extender is recommended to facilitate installation.
2. Values provided in the Housing Dimensions section (Pages 50–51) already accommodate oversized housing.
3. To satisfy fire-resistance rating requirements, the cavity must be filled with noncombustible material under the direction of the EOR.

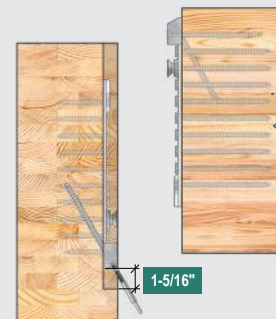

Routing in Secondary Member

Fastener Orientation
 Structural Positioning Screws
 (Refer to Fastener Layout on Page 53)

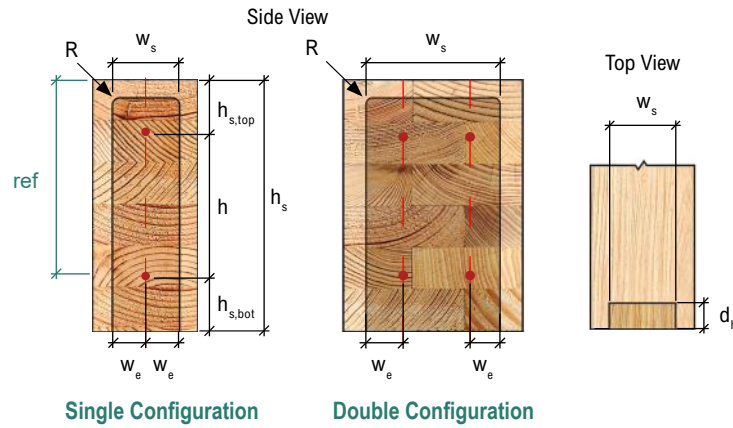

Table 2.21 - Routing Dimensions for RICON S VS Housed in Secondary Member (Beam-End)

Model	Routing Dimensions, in. [mm]								
	h_s	$h_{s,top}$	h	$h_{s,bot}$	w_s		w_e	d_h	R
					Single	Double			
RICON S VS 140 x 60	5.551 [141]	2.205 [56]	3.543 [90]	2.756 [70]	2.441 [62]	5.118 [130]	1.220 [31]	0.945 [24]	0.295 [7.5]
RICON S VS 200 x 60	7.913 [201]	2.205 [56]	4.724 [120]	2.756 [70]	2.441 [62]	5.118 [130]	1.220 [31]	0.945 [24]	0.295 [7.5]
RICON S VS 200 x 80	7.913 [201]	2.756 [70]	4.724 [120]	2.756 [70]	3.228 [82]	6.772 [172]	1.614 [41]	0.945 [24]	0.295 [7.5]
RICON S VS 290 x 80	11.457 [291]	1.575 [40]	5.906 [150]	2.756 [70]	3.228 [82]	6.772 [172]	1.614 [41]	0.945 [24]	0.295 [7.5]
RICON S VS XL 390 x 80	18.622 [473]	3.937 [100]	8.268 [210]	4.724 [120]	3.228 [82]	6.772 [172]	1.614 [41]	0.945 [24]	0.295 [7.5]

Notes:

1. Tabulated values are general guidelines for routing requirements. The EOR and fabricator are responsible for ensuring final routing dimensions account for all project-specific conditions.
2. Tabulated values are minimum requirements unless noted otherwise. Tabulated values for h and R are fixed. Tabulated values for d_h are maximum allowable.
3. Tabulated values account for 0.039 in. [1 mm] on each side of and below the hanger. Larger installation tolerances will increase height and width values accordingly.
4. Tabulated values are based on a gap of 0.039 in. [1 mm] between the primary and secondary member. Larger gaps (such as a typical gap of 1/8 in.) will reduce d_h accordingly.
5. Refer to the Geometry Requirements tables for each respective beam hanger for additional information.
6. Tabulated values for h_p and $h_{p,bot}$ for the RICON S VS XL account for a 1-5/16 in. [33.0 mm] gap below the connector to allow the installation of the fasteners. The resulting hidden void should be protected from fire using industry-approved methods.
7. Manufacturers should adjust the tabulated values based on their specific routing bit sizes if different than R .

RICON S VS Installation Configurations

RICON S VS Connection Applications

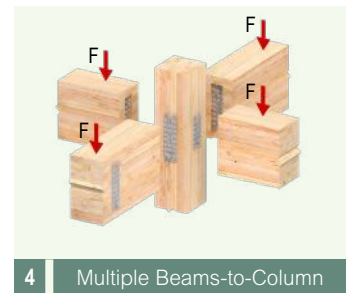
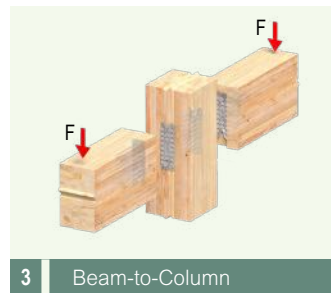
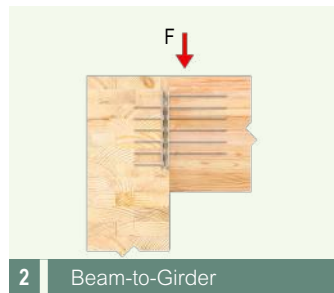
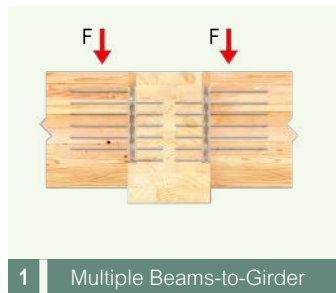
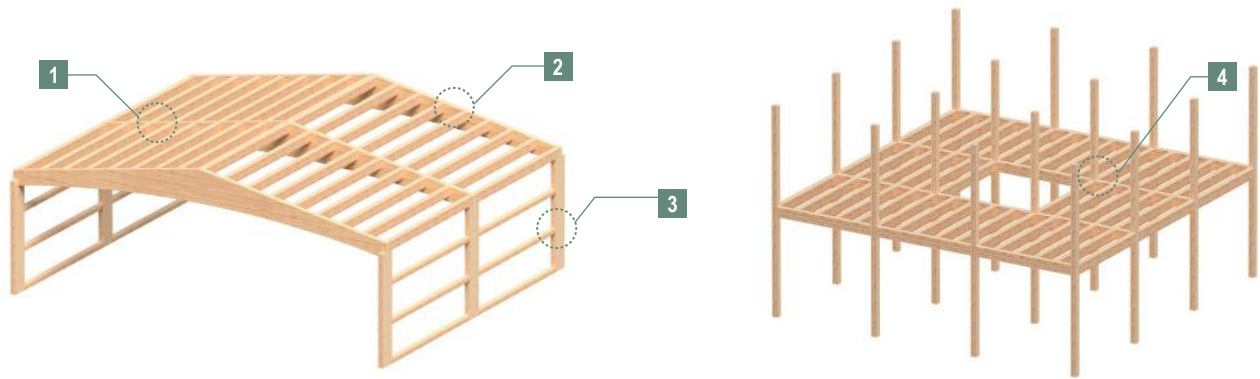

Alternative Connection Applications

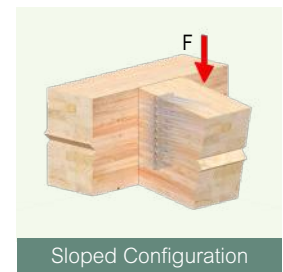
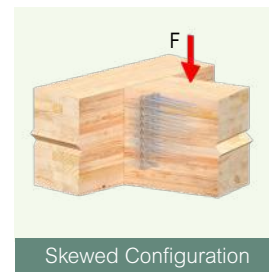
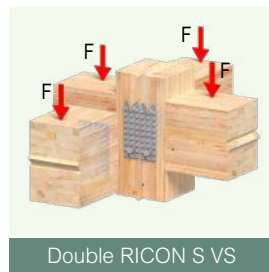
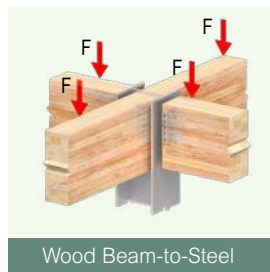

Beam Length Tolerances and Sequencing

Installation sequencing is important, especially for buildings with multiple bays of post-and-beam framing. It is recommended to install the beams starting from one end of the building and progress along the column line. The last beam can be produced slightly over length and cut to size on-site to help mitigate any dimensional tolerance challenges. The RICON S VS features tapered collar bolts and openings that facilitate installation by guiding the secondary beam into place. Beams positioned up to 1/4 in. to either side or slightly out from the primary member will self-center as they slide down.

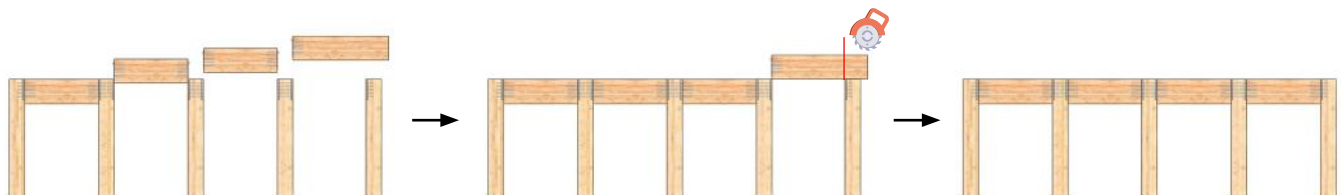
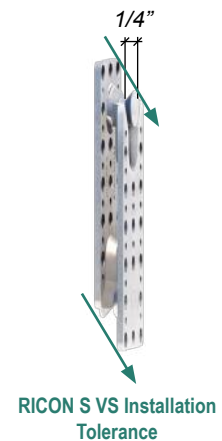

RICON S VS Installation Procedure

Tool Requirements

Tools - Use the Correct Bit

MTC Solutions fasteners should only be driven using RW bits, or appropriately sized star bits. This ensures good centering and positioning with optimal torque transmission. For the RICON S VS, use an RW 40 bit for 5/16 in. screws and an RW 50 bit for 3/8 in. screws.

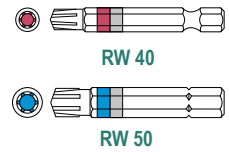

Tools - Use the Correct Drill

Use low-RPM, high-torque drills equipped with a feather (variable speed) trigger to install fasteners. Avoid excessive acceleration and deceleration during the drive-in process. Do not overtorque fasteners. Although impact guns are not expressly prohibited, their use is discouraged - particularly for beam hanger systems - due to an increased risk of overtorquing. Use the appropriate drill chuck size according to the fastener.

Table 2.22 - Recommended Torque, Drill Bits, and Power Drill

Nominal Fastener Diameter [D]		HSS Drill Bit Size	Power Voltage Drill	Allowable Insertion Torque
in.	[mm]	in.	V	lbs. · ft.
5/16	[8]	3/16	20	12.30
3/8	[10]	1/4	60	22.13

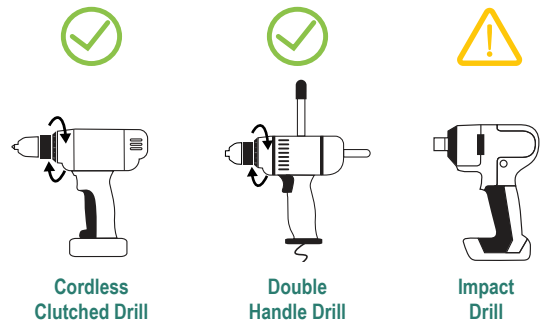

Tools - Predrilling Jig 1/4 in.

The Predrilling Jig ensures precise alignment of the RICON S VS XL 30° inclined fasteners. It guides the drill bit to create accurate pilot hole, and ensures proper fastener seating. The hole in the jig accommodates standard imperial and metric drill bit diameters. For the 3/8 in. inclined fasteners, pilot holes 1/4 in. in diameter and 1 in. long are recommended.

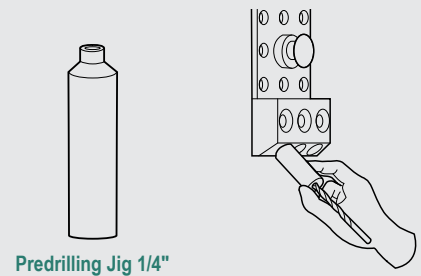

Fastener Layout

Fastener Orientation

- Structural Positioning Screws (without Clip Lock)
- Horizontal Screws
- Inclined Screws

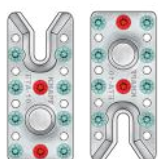

RICON S VS
140 x 60

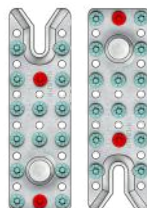

RICON S VS
200 x 60

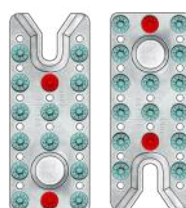

RICON S VS
200 x 80

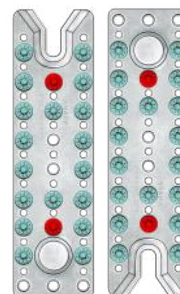

RICON S VS
290 x 80

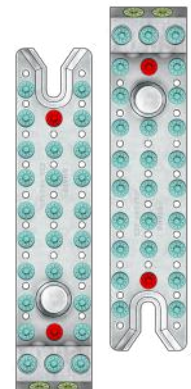

RICON S VS XL
390 x 80

Note:

1. Alternative locations for positioning screws are required when using a Clip Lock System.

General Installation Steps

Estimated Installation Time

The estimated time for a single person to install a complete RICON S VS product is shown in Table 2.23.

This process includes the following steps:

1. Layout (~10%–15%)
2. Positioning (~15%–20%)
3. Pilot Holes (~20%–30%)
4. Screw Installation (~45%–55%)
5. Optional Measures (not included in the time installation % breakdown)

The estimated installation time can be improved upon with efficient fabrication and site practices such as:

1. Drilling pilot holes for the structural positioning screws at the time of fabrication
2. Utilizing templates to drill pilot holes for structural screws
3. Optimizing beam positioning to reduce worker fatigue

Table 2.23 - RICON S VS Estimated Installation Time

RICON S VS Model	Average Installation Time [min.]
140 x 60	9
200 x 60	13
200 x 80	13
290 x 80	14
XL 390 x 80	20

Step-by-Step Installation Guidelines

1.1 Layout - Reference Points

Begin by laying out the installation locations in the primary and secondary members using a pencil and square.

The connector's point of reference is the top of the beam. The **lower structural positioning screw** should be measured from that point of reference.

The **collar bolt** should be at the **bottom** on the primary member and on the **top** on the secondary member.

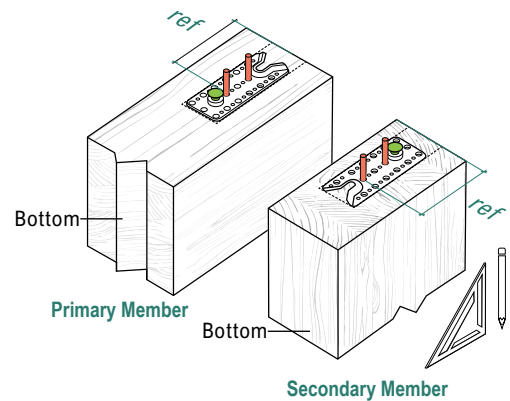

1.2 Layout - Split Lamination Considerations

It is recommended that vertical joints in split lamination glulam beams be tight at the time of manufacturing. Gaps between adjacent plies may occur due to wood shrinkage. Gaps up to 1/8 in. are acceptable for typical RICON S VS installation.

If vertical gaps between plies greater than 1/8 in. exist in the beam-end, the RICON S VS shall be positioned so that fasteners can be installed at least 5/8 in. away from those gaps, as measured from the center of the fastener. Full hanger capacity may be used when installed in this manner.

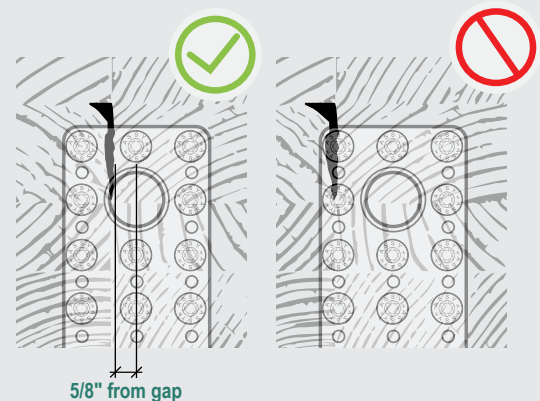

2.1 Positioning - Structural Positioning Screw Installation

Positioning screws ensure accurate placement of the RICON S VS connector. To facilitate accuracy and installation time, it is recommended to predrill the structural positioning screw locations during member fabrication. Note that structural screws cannot be reused if the connector requires adjustment. Install one structural positioning screw into the hole highlighted at the top of the plate. Check to ensure alignment is maintained and then install the second structural positioning screw into the hole highlighted at the bottom of the plate.

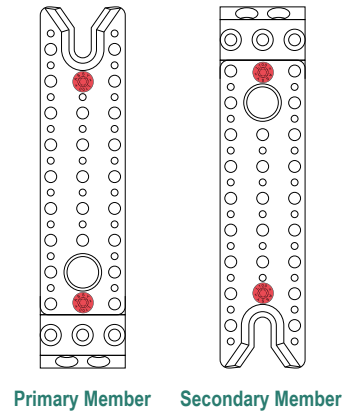

3.1 Pilot Holes - Recommendations

Pilot holes are optional; however, they facilitate screw thread engagement, help reduce splitting risks, ensure a proper penetration path which reduces screw wandering, and reduce insertion torque. For the structural fasteners used with the RICON S VS series, pilot holes 1/4 in. in diameter and 1 in. in length are recommended. The use of MTC Predrilling Jig for the inclined screws of the RICON S VS XL is recommended to ensure proper hole placement.

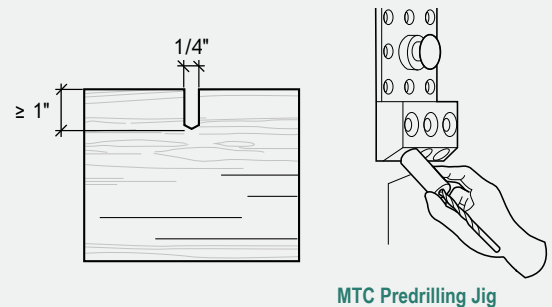

4.1 Screw Installation - Align Drill Bit Axis

Align the drill bit axis parallel to the fastener axis during installation to allow proper torque transmission and to avoid stripping.

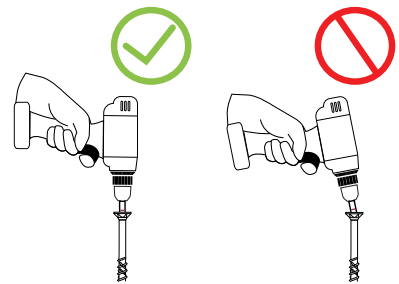

4.2 Screw Installation - Decrease RPM

To avoid overtightening the screw, decrease the rotation speed about 1/2 in. away from the final installed position. This is crucial to prevent wood crushing due to overtightening, which can impact beam hanger tolerances, potentially impeding overall connection assembly. This is especially important when using an impact drill.

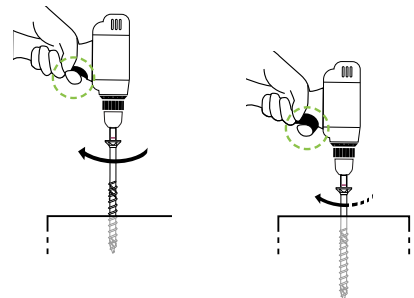

4.3 Screw Installation - Drill Pressure

Do not apply excessive pressure on the drill while driving the fastener to prevent fastener buckling or deviation during installation. Only apply the required force or use the recommended holder case to eliminate cam-out effects.

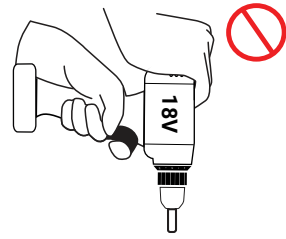

4.4 Screw Installation - One-Step Process

To avoid increased torque peaks caused by stopping and restarting the drive-in process, install the screw in one run until the head is lightly seated against the side member. If necessary, a torque wrench may be used to complete installation immediately after the screw has been driven.

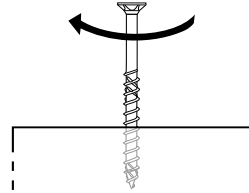

4.5 Screw Installation - Structural Screws

Install properly sized VG CSK screws in all perpendicular holes. If using a Clip Lock system, refer to Step 5.1 and Page 37 for further information.

For the RICON S VS XL only: install 3/8" x 7-7/8" VG CSK screws into all angled holes after all 90° horizontal screws have been installed.

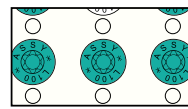

Horizontal Screw

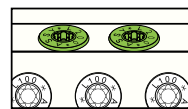

30°, Inclined Screws

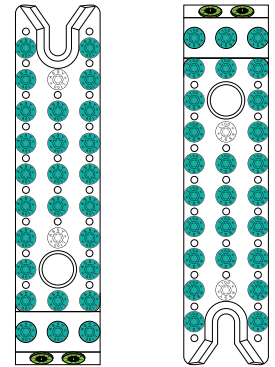

Primary Member Secondary Member

5.1 Optional Measures - Clip Lock Installation

The Clip Lock system must be installed with a modified screw pattern in the primary member. Refer to Page 37 for further details on the screw pattern for the Clip Lock.

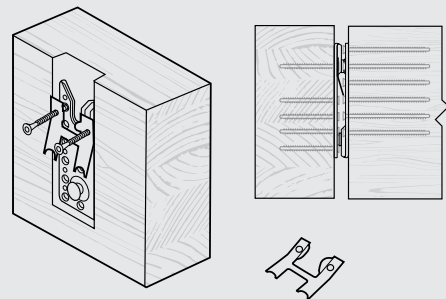

5.2 Optional Measures - Wood Plug

Where connectors are housed in the secondary beam, it is recommended to seal the void in the routing below the connector for aesthetics and fire protection. A wood plug may be used, and installation instructions shall be provided by the EOR.

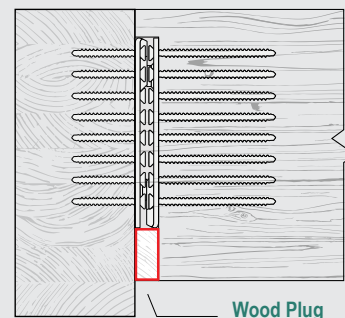



The Hive

Vancouver British Columbia



Clayton Community Center

Surrey, British Columbia

MEGANT

Pre-Engineered Connection System

The MEGANT is a pre-engineered beam-to-beam and beam-to-column connector manufactured from aluminum and consisting of plates and threaded rods for securing the connection. The MEGANT has been tested for the North American market.



Pre-Installable

Pre-installable in a controlled shop environment for a faster on-site installation



Multi-Direction Installation

Installable from all directions (top, bottom, and sides)



Fire-Resistance-Rated

Fire-resistance rating up to 2 hours per NDS 2024



Interstory Drift Tested

Drift ratio exceeding 4% in quasi-static rotational testing



Test-Derived Allowable Loads

Allowable loads derived in accordance with ASTM D7147 and ICC-ES AC13 and AC233



Drop-in Installation

A fast, streamlined repeatable installation process that significantly enhances efficiency

Design

- Wood-to-Wood Design Values

Detailing

- General Detailing Information
- Detailing MEGANT 60 Series
- Detailing MEGANT 100 Series
- Detailing MEGANT 150 Series
- Additional Hanger Placement Considerations

Installation

- Installation Considerations
- Routing Information
- Tool Requirements
- Step-by-Step Installation Guidelines

CERTIFICATIONS

ISO 50001

Energy
Management
System



ETA-15/0667 2019

MEGANT Overview

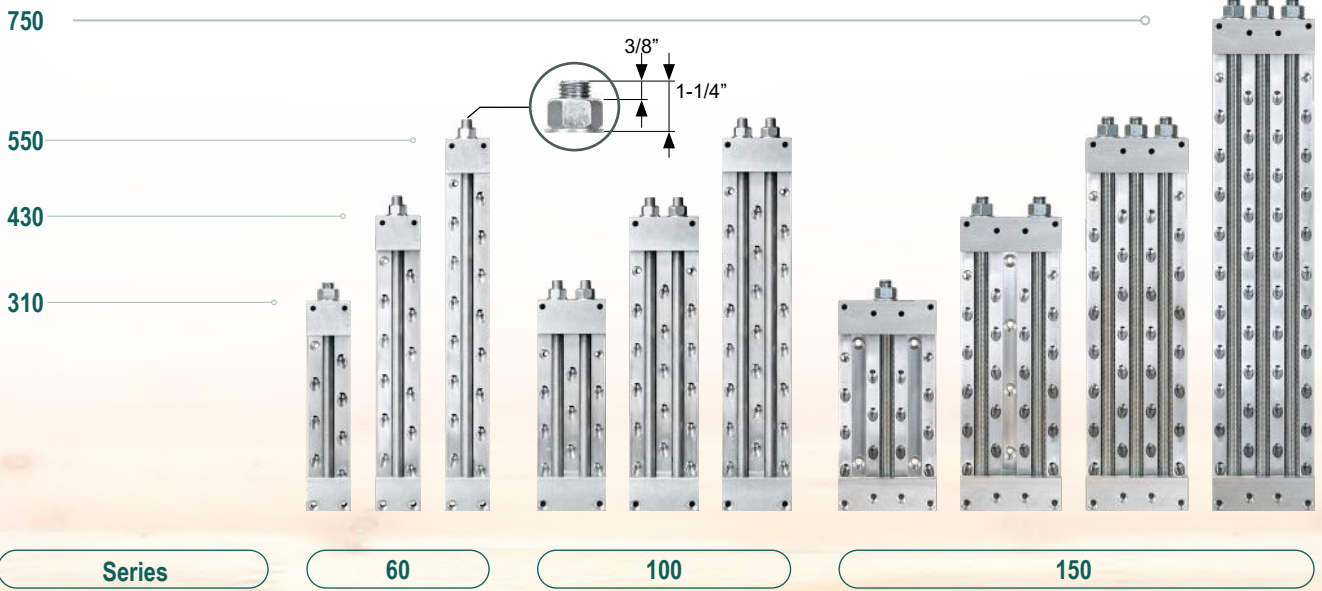
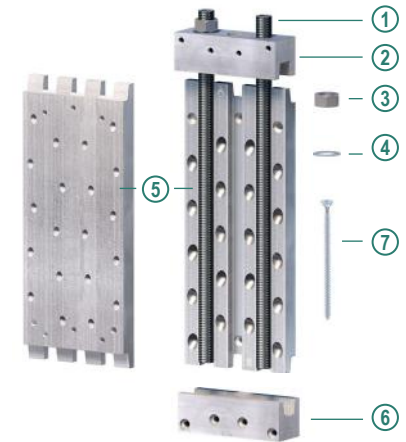

Table 3.1 - MEGANT Hardware Package Installation Overview

MEGANT		Plate Qty.	Fasteners		Threaded Rods		Installation Time
Series	Model		Type	Qty.	Type	Qty.	Min.
60	MEGANT 310 x 60	2	VG CSK 5/16" x 6-1/4"	24	M20 x 340 [13-3/8"] Grade 8.8	1	17
	MEGANT 430 x 60		VG CSK 5/16" x 6-1/4"	32	M20 x 460 [18-1/4"] Grade 8.8	1	21
	MEGANT 550 x 60		VG CSK 5/16" x 6-1/4"	40	M20 x 580 [22-7/8"] Grade 8.8	1	24
100	MEGANT 310 x 100	2	VG CSK 5/16" x 6-1/4"	34	M16 x 340 [13-3/8"] Grade 8.8	2	23
	MEGANT 430 x 100		VG CSK 5/16" x 6-1/4"	46	M16 x 460 [18-1/4"] Grade 8.8	2	27
	MEGANT 550 x 100		VG CSK 5/16" x 6-1/4"	58	M16 x 580 [22-7/8"] Grade 8.8	2	32
150	MEGANT 310 x 150	2	VG CSK 5/16" x 6-1/4"	48	M20 x 340 [13-3/8"] Grade 8.8	1	31
	MEGANT 430 x 150		VG CSK 5/16" x 6-1/4"	64	M20 x 460 [18-1/4"] Grade 8.8	2	37
	MEGANT 550 x 150		VG CSK 5/16" x 6-1/4"	80	M20 x 580 [22-7/8"] Grade 8.8	3	44
	MEGANT 730 x 150		VG CSK 5/16" x 6-1/4"	104	M20 x 760 [30"] Grade 8.8	3	53



Product Kit Details



- ① Threaded Rod
- ② Threaded Clamping Jaw
- ③ Hex Nut
- ④ Washer
- ⑤ Connector Plates
- ⑥ Clamping Jaw
- ⑦ VG CSK

Notes:

1. Subsequent tabulated capacities in this chapter assume connectors are installed with fasteners specified ASSY VG CSK fasteners specified in this table and in accordance with ICC-ESR 3178 (2024).
2. The estimated installation time is based on a time study and includes steps for layout and positioning, drilling a 1 in. deep pilot hole for each fastener, structural screw installation for both plates, clamping jaw installation, and threaded rod installation. Refer to the General Installation Steps (Page 81) for more information.

MEGANT Force Transfer Principle

The following figures highlight the flow of forces through various components of the MEGANT connector, showing why the fasteners and connector must be installed as specified.

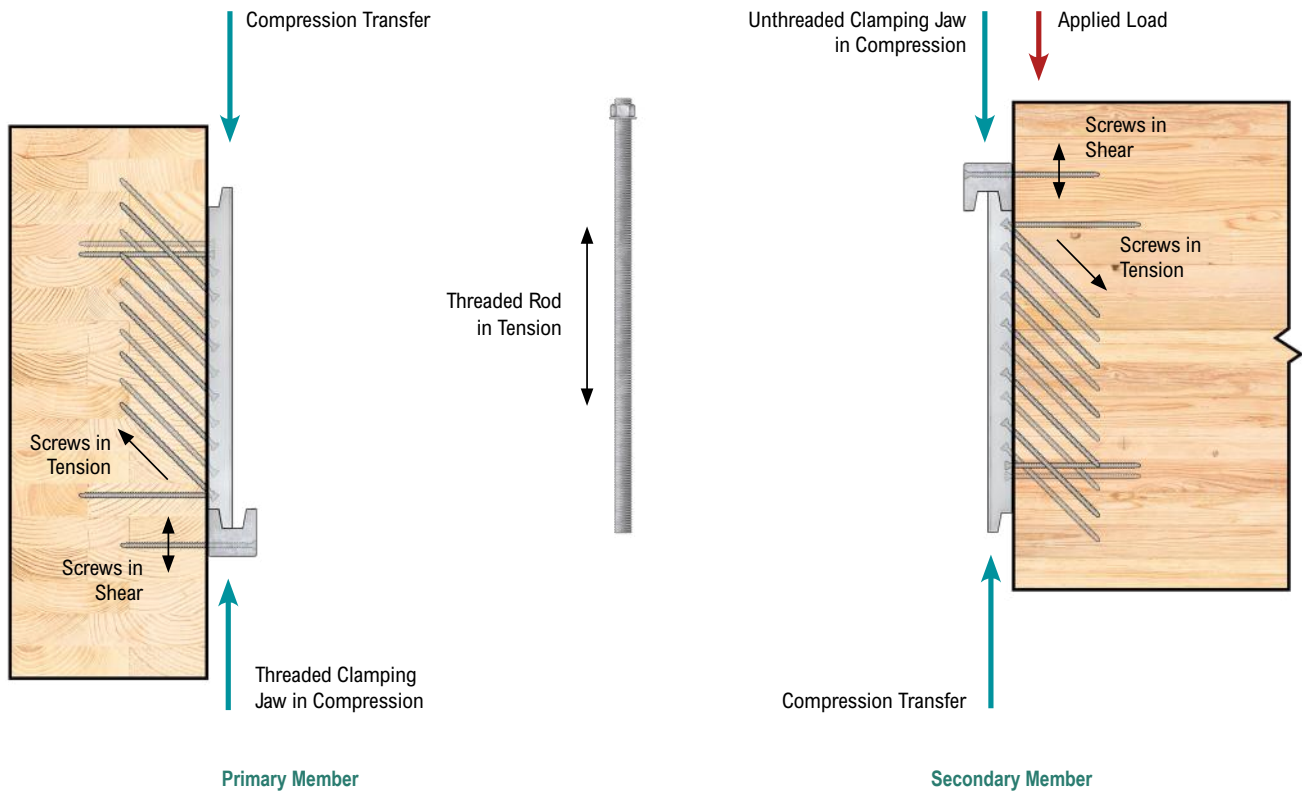

MEGANT Seismic Performance

MTC has conducted extensive quasi-static, interstory, and component testing on the MEGANT connector. The results have demonstrated its robust performance under both axial and drift demands.

- The MEGANT connector is capable of resisting axial forces in excess of 5% of its download capacity while fully loaded in accordance with ASCE 7-22 Sections 1.4.3 and 12.1.4.
- The MEGANT connector can accommodate drifts over 4% while fully loaded, which satisfies the drift limits specified in ASCE 7-22 Table 12-12.1.

Contact MTC Technical Support for additional details for accommodating seismic loads in your design.

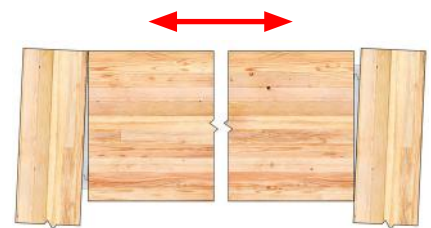

MEGANT Design Information

Wood-to-Wood Design Values

Table 3.2 - Allowable Loads for MEGANT in Wood-to-Wood Connections

MEGANT		Minimum Secondary Beam Section Dimensions [in.]			Specific Gravity [G]	Allowable Download [lb.]
Model	Configuration	No FRR	1-hr FRR	2-hr FRR		
MEGANT 310 x 60	Single	3-15/32 x 16-5/32	5-25/32 x 16-13/32	8-3/8 x 18-3/32	≥ 0.42	8,660
					≥ 0.50	9,820
	Double	6-1/32 x 16-5/32	8-5/16 x 16-13/32	10-29/32 x 18-3/32	≥ 0.42	14,722
					≥ 0.50	16,694
MEGANT 430 x 60	Single	3-15/32 x 20-7/8	5-25/32 x 21-1/8	8-3/8 x 22-13/16	≥ 0.42	11,350
					≥ 0.50	12,830
	Double	6-1/32 x 20-7/8	8-5/16 x 21-1/8	10-29/32 x 22-13/16	≥ 0.42	19,295
					≥ 0.50	21,811
MEGANT 550 x 60	Single	3-15/32 x 25-19/32	5-25/32 x 25-27/32	8-3/8 x 27-9/16	≥ 0.42	12,830
					≥ 0.50	
	Double	6-1/32 x 25-19/32	8-5/16 x 25-27/32	10-29/32 x 27-9/16	≥ 0.42	21,811
					≥ 0.50	
MEGANT 310 x 100	Single	5-1/32 x 14-13/16	7-11/32 x 16-1/4	9-15/16 x 17-15/16	≥ 0.42	11,140
					≥ 0.50	12,610
	Double	9-1/8 x 14-13/16	11-7/16 x 16-1/4	14-1/32 x 17-15/16	≥ 0.42	18,938
					≥ 0.50	21,437
MEGANT 430 x 100	Single	5-1/32 x 19-17/32	7-11/32 x 20-31/32	9-15/16 x 22-21/32	≥ 0.42	15,630
					≥ 0.50	17,700
	Double	9-1/8 x 19-17/32	11-7/16 x 20-31/32	14-1/32 x 22-21/32	≥ 0.42	26,571
					≥ 0.50	30,090
MEGANT 550 x 100	Single	5-1/32 x 24-1/4	7-11/32 x 25-11/16	9-15/16 x 27-3/8	≥ 0.42	19,500
					≥ 0.50	
	Double	9-1/8 x 24-1/4	11-7/16 x 25-11/16	14-1/32 x 27-3/8	≥ 0.42	33,150
					≥ 0.50	
MEGANT 310 x 150	Single	7 x 14-13/16	9-5/16 x 16-1/4	11-29/32 x 17-15/16	≥ 0.42	14,410
					≥ 0.50	16,320
	Double	13-1/16 x 14-13/16	15-3/8 x 16-1/4	17-31/32 x 17-15/16	≥ 0.42	24,497
					≥ 0.50	27,744
MEGANT 430 x 150	Single	7 x 19-17/32	9-5/16 x 20-31/32	11-29/32 x 22-21/32	≥ 0.42	24,020
					≥ 0.50	27,200
	Double	13-1/16 x 19-17/32	15-3/8 x 20-31/32	17-31/32 x 22-21/32	≥ 0.42	40,834
					≥ 0.50	46,240
MEGANT 550 x 150	Single	7 x 24-1/4	9-5/16 x 25-11/16	11-29/32 x 27-3/8	≥ 0.42	28,030
					≥ 0.50	31,730
	Double	13-1/16 x 24-1/4	15-3/8 x 25-11/16	17-31/32 x 27-3/8	≥ 0.42	47,651
					≥ 0.50	53,941
MEGANT 730 x 150	Single	7 x 30-15/16	9-5/16 x 32-25/32	11-29/32 x 34-15/32	≥ 0.42	32,630
					≥ 0.50	
	Double	13-1/16 x 30-15/16	15-3/8 x 32-25/32	17-31/32 x 34-15/32	≥ 0.42	55,471
					≥ 0.50	

Notes:

1. Connection design must meet all relevant requirements of the General Notes to the Designer section.
2. Screw installation must follow the patterns presented in the Installation and Tolerances section.
3. Tabulated allowable load capacities are derived in accordance with ASTM D7147 and ICC-ES AC13 and AC233.
4. Minimum dimensions for secondary members are derived from minimum fastener end and edge distances and apply to scenarios without FRR only.
5. Tabulated capacities assume members are positioned at beam depths such that reinforcement is not required [refer to Appendix C (Page 100) for more information]. It is the responsibility of the EOR to ensure the primary and secondary members have adequate capacity to resist connection forces.

MEGANT 60 Series - Geometry Requirements

MEGANT 60 Series - Connector Geometry

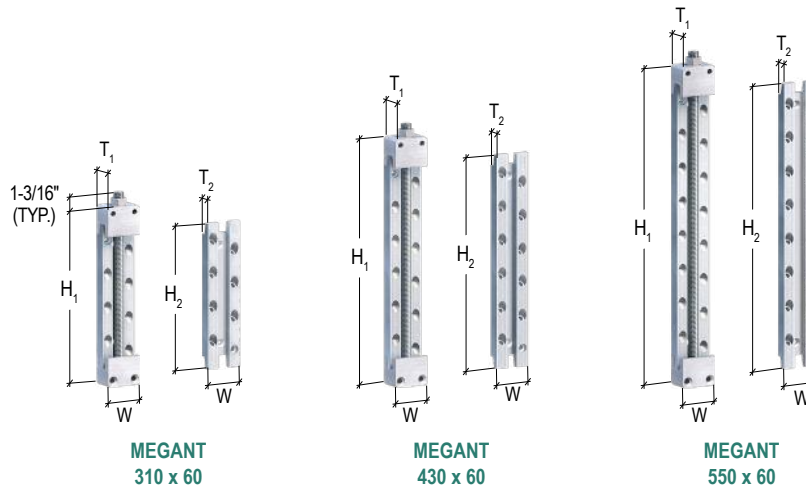

Table 3.3 - MEGANT 60 Geometry

Connector Geometry	Model		
	MEGANT 310 x 60	MEGANT 430 x 60	MEGANT 550 x 60
	[in.]		
H ₁	12-7/32	16-15/16	21-21/32
H ₂	9-27/32	14-9/16	19-9/32
T ₁	1-9/16	1-9/16	1-9/16
T ₂	25/32	25/32	25/32
W	2-3/8	2-3/8	2-3/8

Note:

1. Refer to Appendix D: Product Specifications (Page 109) for additional product specifications.

Secondary Member Geometry Requirements



Unhoused

Housed

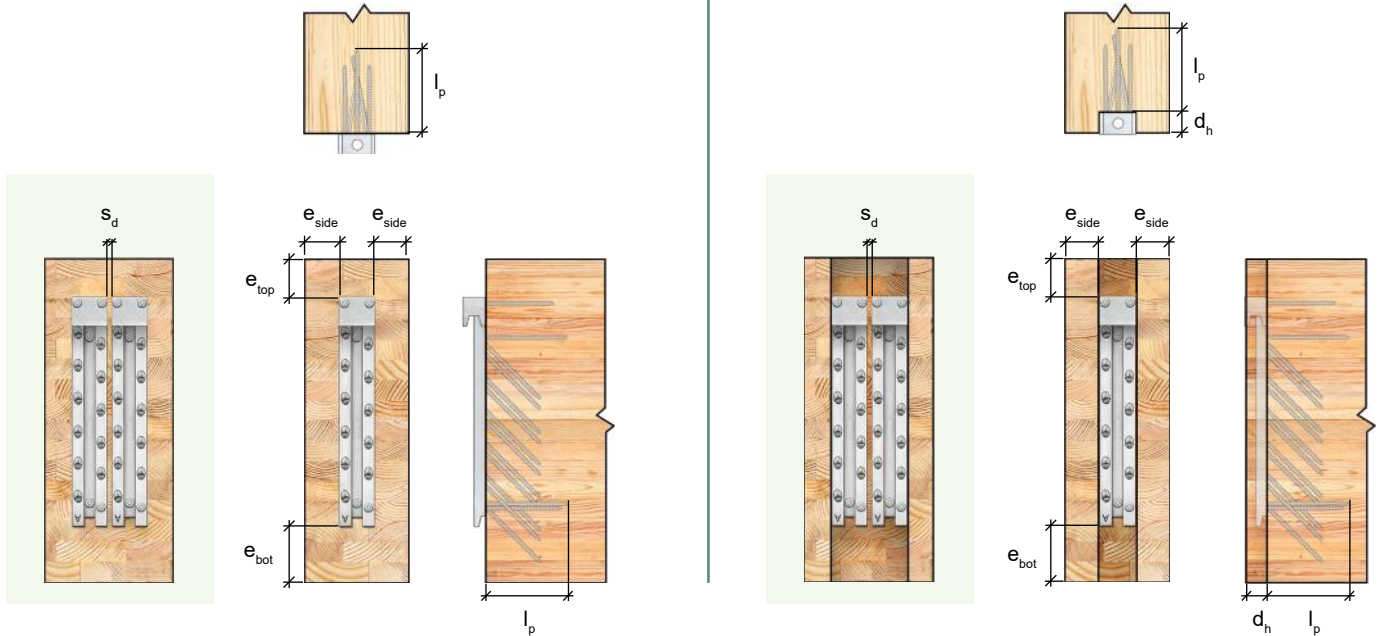

Table 3.4 - MEGANT 60 Geometry Requirements for Secondary Member

MEGANT 60		Geometry Requirements [in.]									
		l_p	e_{top}	No FRR		1-hr FRR		2-hr FRR		d_h	s_d
e_{side}	e_{bot}			e_{side}	e_{bot}	e_{side}	e_{bot}				
MEGANT 310 x 60	Single	5-31/32	1-31/32	9/16	3-5/32	1-23/32	3-13/32	3	5-3/32	1-17/32	N/A
	Double	5-31/32	1-31/32	9/16	3-5/32	1-23/32	3-13/32	3	5-3/32	1-17/32	3/16
MEGANT 430 x 60	Single	5-31/32	1-31/32	9/16	3-5/32	1-23/32	3-13/32	3	5-3/32	1-17/32	N/A
	Double	5-31/32	1-31/32	9/16	3-5/32	1-23/32	3-13/32	3	5-3/32	1-17/32	3/16
MEGANT 550 x 60	Single	5-31/32	1-31/32	9/16	3-5/32	1-23/32	3-13/32	3	5-3/32	1-17/32	N/A
	Double	5-31/32	1-31/32	9/16	3-5/32	1-23/32	3-13/32	3	5-3/32	1-17/32	3/16

Notes:

1. Connection design must meet all relevant requirements of the General Notes to the Designer section.
2. Screw installation must follow the patterns presented in the Installation section.
3. Tabulated values are minimum requirements unless noted otherwise. Tabulated values for l_p are fixed. Tabulated values for d_h are maximum values based on a gap of 0.039 in. [1 mm] between the primary and secondary member. Larger gaps (such as a typical gap of 1/8 in.) will reduce d_h accordingly.
4. Tabulated values that are not dependent on FRR, as well as those for secondary beams with no FRR, are based on minimum end and edge distances.
5. Minimum dimensions for beams with an FRR are based on minimum wood cover requirements specified in NDS 2024 Chapter 16.5. Beam sizes satisfying an FRR assume a fire-resistant joint compliant with FDS 2024 Section 2.5.1.3. and that any void below the connector in the routing has been sealed with a wood plug. The tip of the inclined screws are permitted to penetrate the minimum wood cover.
6. Dimensions for 1-hr and 2-hr FRRs are based on the unthreaded jaw being installed on top, with the threaded rod and nut being installed from above as shown in the examples above.

Primary Member Geometry Requirements - Beam/Girder



Unhoused

Housed

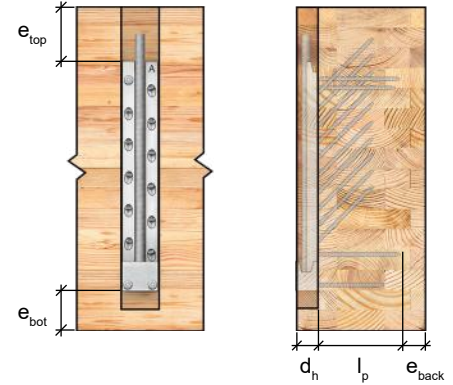
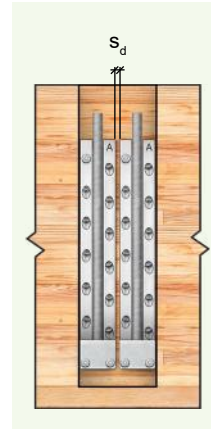
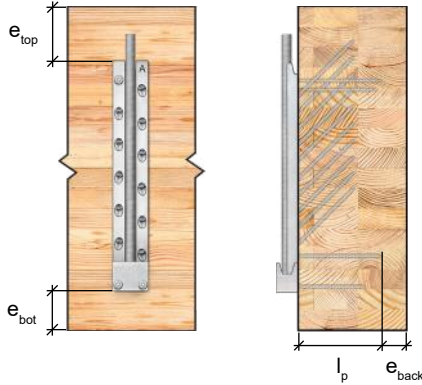
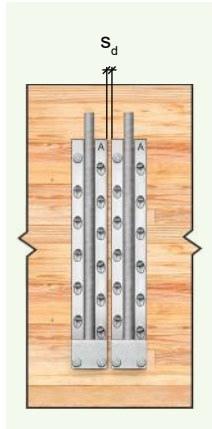
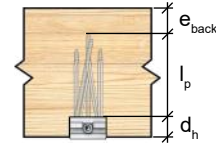
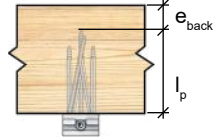

Table 3.5 - MEGANT 60 Geometry Requirements for Primary Member (Beam/Girder)

MEGANT 60		Geometry Requirements [in.]									
Model	Configuration	l_p	e_{top}	No FRR		1-hr FRR		2-hr FRR		d_h	s_d
				e_{bot}	e_{back}	e_{bot}	e_{back}	e_{bot}	e_{back}		
MEGANT 310 x 60	Single	5-31/32	3-5/32	1-31/32	13/32	2-1/4	1-23/32	3-15/16	3	1-17/32	N/A
	Double	5-31/32	3-5/32	1-31/32	13/32	2-1/4	1-23/32	3-15/16	3	1-17/32	3/16
MEGANT 430 x 60	Single	5-31/32	3-5/32	1-31/32	13/32	2-1/4	1-23/32	3-15/16	3	1-17/32	N/A
	Double	5-31/32	3-5/32	1-31/32	13/32	2-1/4	1-23/32	3-15/16	3	1-17/32	3/16
MEGANT 550 x 60	Single	5-31/32	3-5/32	1-31/32	13/32	2-1/4	1-23/32	3-15/16	3	1-17/32	N/A
	Double	5-31/32	3-5/32	1-31/32	13/32	2-1/4	1-23/32	3-15/16	3	1-17/32	3/16

Notes:

1. Connection design must meet all relevant requirements of the General Notes to the Designer section.
2. Screw installation must follow the patterns presented in the Installation section.
3. Tabulated values are minimum requirements unless noted otherwise. Tabulated values for l_p are fixed. Tabulated values for d_h are maximum values based on a gap of 0.039 in. [1 mm] between the primary and secondary member. Larger gaps (such as a typical gap of 1/8 in.) will reduce d_h accordingly.
4. Tabulated values that are not dependent on FRR, as well as those for primary beams with no FRR, are based on minimum end and edge distances.
5. Minimum dimensions for beams with an FRR are based on minimum wood cover requirements specified in NDS 2024 Chapter 16.5. Beam sizes satisfying an FRR assume a fire-resistant joint compliant with FDS 2024 Section 2.5.1.3. and that any void below the connector in the routing has been sealed with a wood plug. The tip of the inclined screws are permitted to penetrate the minimum wood cover.
6. Values for e_{top} are minimum requirements based on minimum end and edge distance, and may need to be adjusted to align with the hanger placement in the secondary beam
7. Dimensions for 1-hr and 2-hr FRRs are based on the threaded jaw being installed on the bottom, with the threaded rod and nut being installed from above as shown in the examples above.

Primary Member Geometry Requirements - Column



Unhoused

Housed

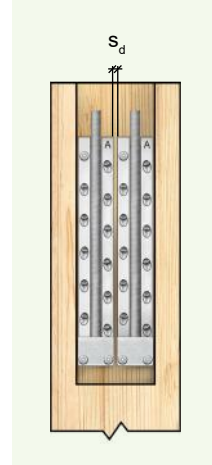
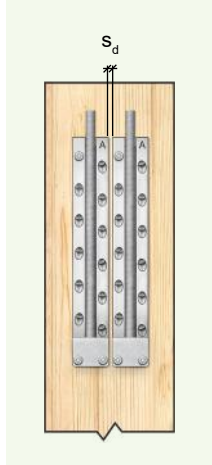
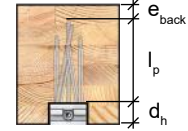
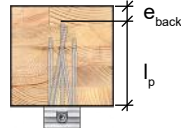

Table 3.6 - MEGANT 60 Geometry Requirements for Primary Member (Column)

MEGANT 60		Geometry Requirements [in.]									
		l_p	e_{top}	No FRR		1-hr FRR		2-hr FRR		d_h	s_d
				e_{side}	e_{back}	e_{side}	e_{back}	e_{side}	e_{back}		
MEGANT 310 x 60	Single	5-31/32	3-5/32	9/16	13/32	1-23/32	1-23/32	3	3	1-17/32	N/A
	Double	5-31/32	3-5/32	9/16	13/32	1-23/32	1-23/32	3	3	1-17/32	3/16
MEGANT 430 x 60	Single	5-31/32	3-5/32	9/16	13/32	1-23/32	1-23/32	3	3	1-17/32	N/A
	Double	5-31/32	3-5/32	9/16	13/32	1-23/32	1-23/32	3	3	1-17/32	3/16
MEGANT 550 x 60	Single	5-31/32	3-5/32	9/16	13/32	1-23/32	1-23/32	3	3	1-17/32	N/A
	Double	5-31/32	3-5/32	9/16	13/32	1-23/32	1-23/32	3	3	1-17/32	3/16

Notes:

1. Connection design must meet all relevant requirements of the General Notes to the Designer section.
2. Screw installation must follow the patterns presented in the Installation section.
3. Tabulated values presented are minimum requirements unless noted otherwise. Tabulated values for l_p are fixed. Tabulated values for d_h are maximum values based on a gap of 0.039 in. [1 mm] between the primary and secondary member. Larger gaps (such as a typical gap of 1/8 in.) will reduce d_h accordingly.
4. Tabulated values that are not dependent on FRR, as well as those for columns with no FRR, are based on minimum end and edge distances.
5. Minimum dimensions for columns with an FRR are based on minimum wood cover requirements specified in NDS 2024 Chapter 16.5. Column sizes satisfying an FRR assume a fire-resistant joint compliant with FDS 2024 Section 2.5.1.3. and that any void below the connector in the routing has been sealed with a wood plug. The tip of the inclined screws are permitted to penetrate the minimum wood cover.
6. Values for e_{top} are minimum requirements based on minimum end and edge distance, and may need to be adjusted to align with the hanger placement in the secondary beam.
7. Dimensions for 1-hr and 2-hr FRRs are based on the threaded jaw being installed on the bottom, with the threaded rod and nut being installed from above as shown in the examples above.

MEGANT 100 Series - Geometry Requirements

MEGANT 100 Series - Connector Geometry

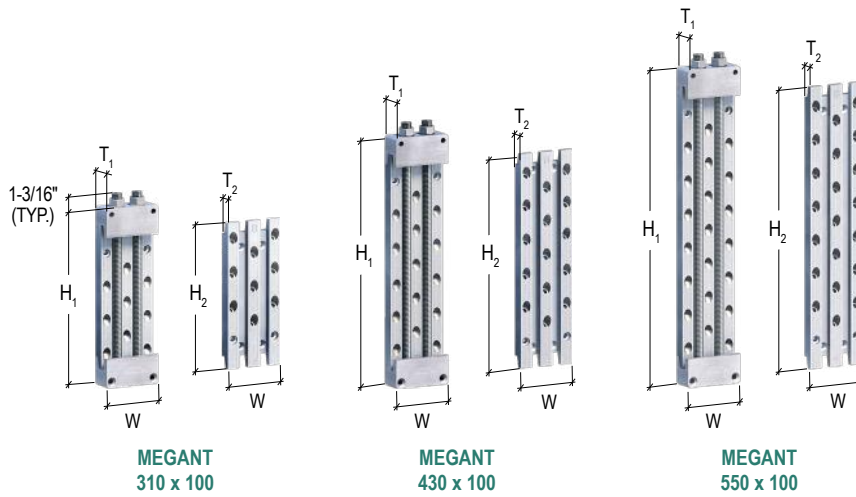

Table 3.7 - MEGANT 100 Geometry

Connector Geometry	Model		
	MEGANT 310 x 100	MEGANT 430 x 100	MEGANT 550 x 100
	[in.]		
H ₁	12-7/32	16-15/16	21-21/32
H ₂	9-27/32	14-9/16	19-9/32
T ₁	1-9/16	1-9/16	1-9/16
T ₂	25/32	25/32	25/32
W	3-15/16	3-15/16	3-15/16

Note:

1. Refer to Appendix D: Product Specifications (Page 109) for additional product specifications.

Secondary Member Geometry Requirements



Unhoused

Housed

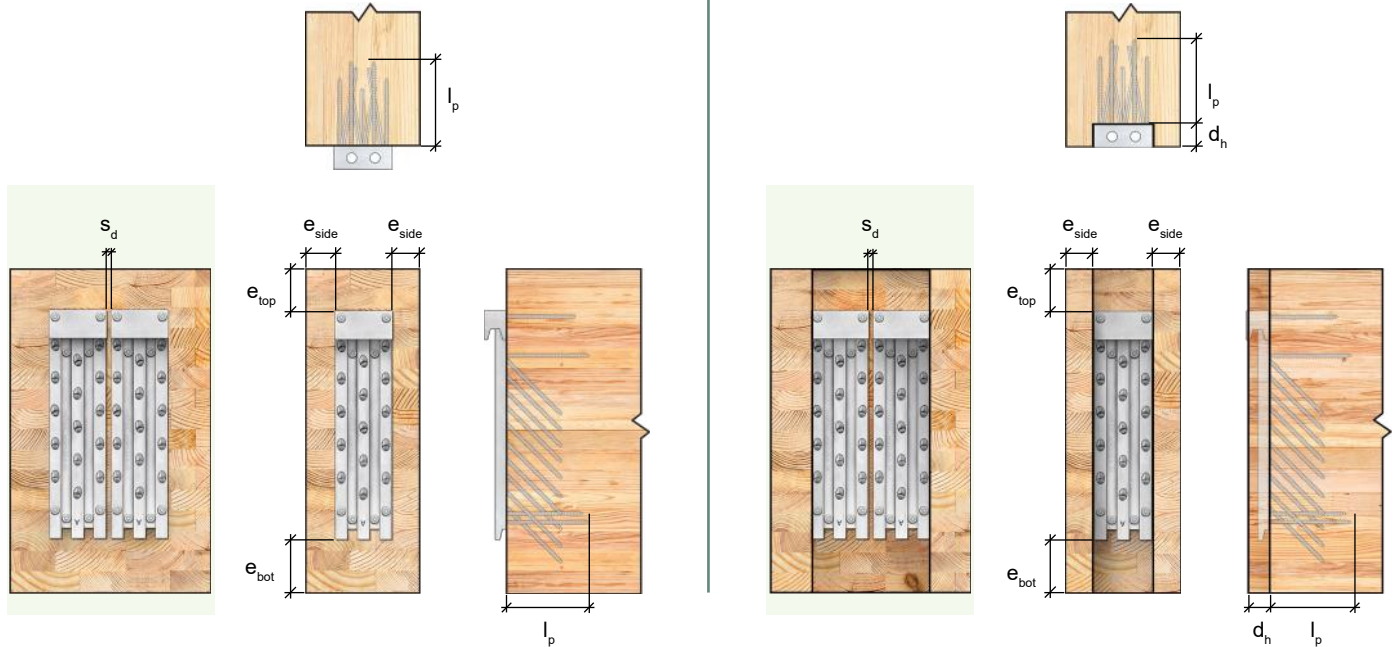

Table 3.8 - MEGANT 100 Geometry Requirements for Secondary Member

MEGANT 100		Geometry Requirements [in.]									
		l _p	e _{top}	No FRR		1-hr FRR		2-hr FRR		d _h	s _d
				e _{side}	e _{bot}	e _{side}	e _{bot}	e _{side}	e _{bot}		
Model	Configuration										
MEGANT 310 x 100	Single	5-31/32	1-13/16	9/16	1-31/32	1-23/32	3-13/32	3	5-3/32	1-17/32	N/A
	Double	5-31/32	1-13/16	9/16	1-31/32	1-23/32	3-13/32	3	5-3/32	1-17/32	5/32
MEGANT 430 x 100	Single	5-31/32	1-13/16	9/16	1-31/32	1-23/32	3-13/32	3	5-3/32	1-17/32	N/A
	Double	5-31/32	1-13/16	9/16	1-31/32	1-23/32	3-13/32	3	5-3/32	1-17/32	5/32
MEGANT 550 x 100	Single	5-31/32	1-13/16	9/16	1-31/32	1-23/32	3-13/32	3	5-3/32	1-17/32	N/A
	Double	5-31/32	1-13/16	9/16	1-31/32	1-23/32	3-13/32	3	5-3/32	1-17/32	5/32

Notes:

1. Connection design must meet all relevant requirements of the General Notes to the Designer section.
2. Screw installation must follow the patterns presented in the Installation section.
3. Tabulated values presented are minimum requirements unless noted otherwise. Tabulated values for l_p are fixed. Tabulated values for d_h are maximum values based on a gap of 0.039 in. [1 mm] between the primary and secondary member. Larger gaps (such as a typical gap of 1/8 in.) will reduce d_h accordingly.
4. Tabulated values that are not dependent on FRR, as well as those for secondary beams with no FRR, are based on minimum end and edge distances.
5. Minimum dimensions for beams with an FRR are based on minimum wood cover requirements specified in NDS 2024 Chapter 16.5. Beam sizes satisfying an FRR assume a fire-resistant joint compliant with FDS 2024 Section 2.5.1.3. and that any void below the connector in the routing has been sealed with a wood plug. The tip of the inclined screws are permitted to penetrate the minimum wood cover.
6. Dimensions for 1-hr and 2-hr FRRs are based on the unthreaded jaw being installed on top, with the threaded rod and nut being installed from above as shown in the examples above.

Primary Member Geometry Requirements - Beam/Girder



Unhoused

Housed

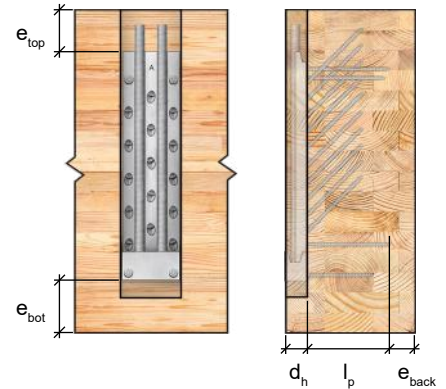
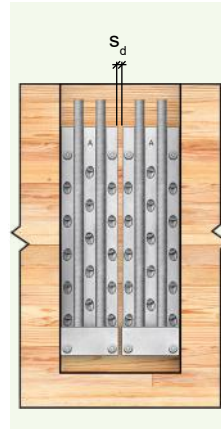
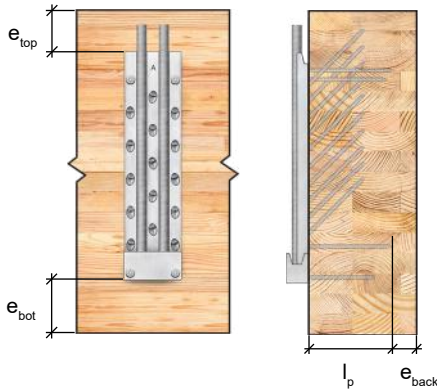
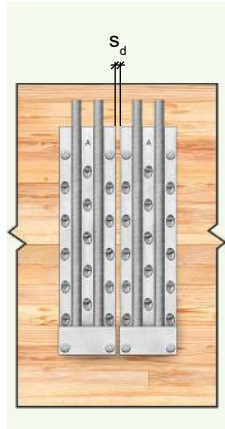
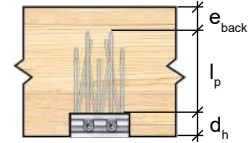
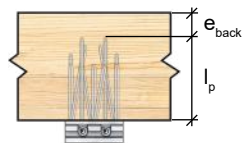

Table 3.9 - MEGANT 100 Geometry Requirements for Primary Member (Beam/Girder)

MEGANT 100		Geometry Requirements [in.]									
		l _p	e _{top}	No FRR		1-hr FRR		2-hr FRR		d _h	s _d
				e _{bot}	e _{back}	e _{bot}	e _{back}	e _{bot}	e _{back}		
MEGANT 310 x 100	Single	5-31/32	3	1-13/16	13/32	2-1/4	1-23/32	3-15/16	3	1-17/32	N/A
	Double	5-31/32	3	1-13/16	13/32	2-1/4	1-23/32	3-15/16	3	1-17/32	5/32
MEGANT 430 x 100	Single	5-31/32	3	1-13/16	13/32	2-1/4	1-23/32	3-15/16	3	1-17/32	N/A
	Double	5-31/32	3	1-13/16	13/32	2-1/4	1-23/32	3-15/16	3	1-17/32	5/32
MEGANT 550 x 100	Single	5-31/32	3	1-13/16	13/32	2-1/4	1-23/32	3-15/16	3	1-17/32	N/A
	Double	5-31/32	3	1-13/16	13/32	2-1/4	1-23/32	3-15/16	3	1-17/32	5/32

Notes:

1. Connection design must meet all relevant requirements of the General Notes to the Designer section.
2. Screw installation must follow the patterns presented in the Installation section.
3. Tabulated values presented are minimum requirements unless noted otherwise. Tabulated values for l_p are fixed. Tabulated values for d_h are maximum values based on a gap of 0.039 in. [1 mm] between the primary and secondary member. Larger gaps (such as a typical gap of 1/8 in.) will reduce d_h accordingly.
4. Tabulated values that are not dependent on FRR, as well as those for primary beams with no FRR, are based on minimum end and edge distances.
5. Minimum dimensions for beams with an FRR are based on minimum wood cover requirements specified in NDS 2024 Chapter 16.5. Beam sizes satisfying an FRR assume a fire-resistant joint compliant with FDS 2024 Section 2.5.1.3. and that any void below the connector in the routing has been sealed with a wood plug. The tip of the inclined screws are permitted to penetrate the minimum wood cover.
6. Values for e_{top} are minimum requirements based on minimum end and edge distance, and may need to be adjusted to align with the hanger placement in the secondary beam.
7. Dimensions for 1-hr and 2-hr FRRs are based on the threaded jaw being installed on the bottom, with the threaded rod and nut being installed from above as shown in the examples above.

Primary Member Geometry Requirements - Column



Unhoused

Housed

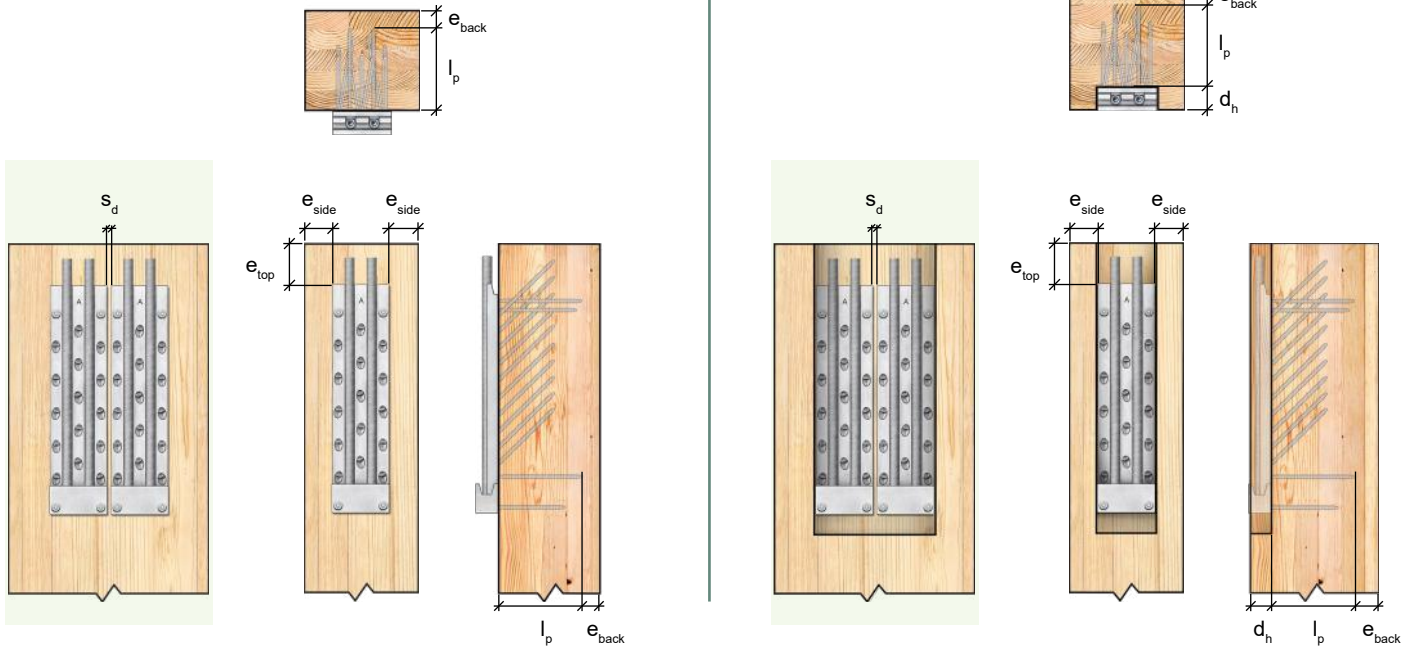

Table 3.10 - MEGANT 100 Geometry Requirements for Primary Member (Column)

MEGANT 100		Geometry Requirements [in.]									
		l_p	e_{top}	No FRR		1-hr FRR		2-hr FRR		d_h	s_d
e_{side}	e_{back}			e_{side}	e_{back}	e_{side}	e_{back}				
MEGANT 310 x 100	Single	5-31/32	3	9/16	13/32	1-23/32	1-23/32	3	3	1-17/32	N/A
	Double	5-31/32	3	9/16	13/32	1-23/32	1-23/32	3	3	1-17/32	5/32
MEGANT 430 x 100	Single	5-31/32	3	9/16	13/32	1-23/32	1-23/32	3	3	1-17/32	N/A
	Double	5-31/32	3	9/16	13/32	1-23/32	1-23/32	3	3	1-17/32	5/32
MEGANT 550 x 100	Single	5-31/32	3	9/16	13/32	1-23/32	1-23/32	3	3	1-17/32	N/A
	Double	5-31/32	3	9/16	13/32	1-23/32	1-23/32	3	3	1-17/32	5/32

Notes:

1. Connection design must meet all relevant requirements of the General Notes to the Designer section.
2. Screw installation must follow the patterns presented in the Installation section.
3. Tabulated values presented are minimum requirements unless noted otherwise. Tabulated values for l_p are fixed. Tabulated values for d_h are maximum values based on a gap of 0.039 in. [1 mm] between the primary and secondary member. Larger gaps (such as a typical gap of 1/8 in.) will reduce d_h accordingly.
4. Tabulated values that are not dependent on FRR, as well as those for columns with no FRR, are based on minimum end and edge distances.
5. Minimum dimensions for columns with an FRR are based on minimum wood cover requirements specified in NDS 2024 Chapter 16.5. Column sizes satisfying an FRR assume a fire-resistant joint compliant with FDS 2024 Section 2.5.1.3. and that any void below the connector in the routing has been sealed with a wood plug. The tip of the inclined screws are permitted to penetrate the minimum wood cover.
6. Values for e_{top} are minimum requirements based on minimum end and edge distance, and may need to be adjusted to align with the hanger placement in the secondary beam.
7. Dimensions for 1-hr and 2-hr FRRs are based on the threaded jaw being installed on the bottom, with the threaded rod and nut being installed from above as shown in the examples above.

MEGANT 150 Series - Geometry Requirements

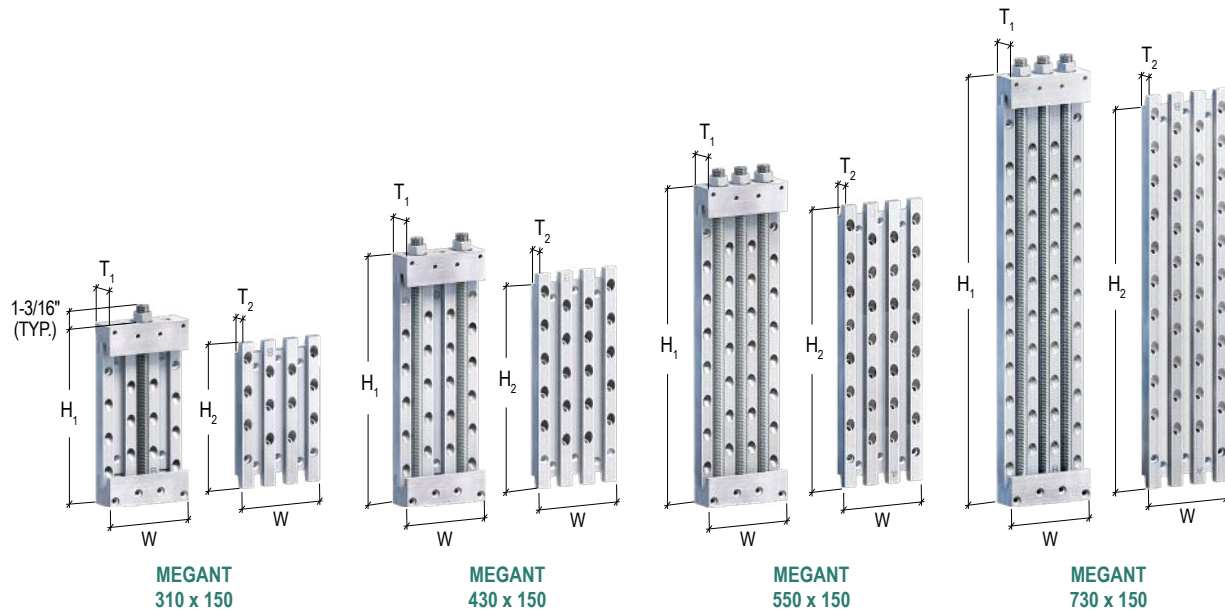

Table 3.11 - MEGANT 150 Geometry

Connector Geometry	Model			
	MEGANT 310 x 150	MEGANT 430 x 150	MEGANT 550 x 150	MEGANT 730 x 150
	[in.]			
H ₁	12-7/32	16-15/16	21-21/32	28-3/4
H ₂	9-27/32	14-9/16	19-9/32	26-3/8
T ₁	1-31/32	1-31/32	1-31/32	1-31/32
T ₂	31/32	31/32	31/32	31/32
W	5-29/32	5-29/32	5-29/32	5-29/32

Note:

1. Refer to Appendix D: Product Specifications (Page 109) for additional product specifications.

Secondary Member Geometry Requirements



Unhoused

Housed

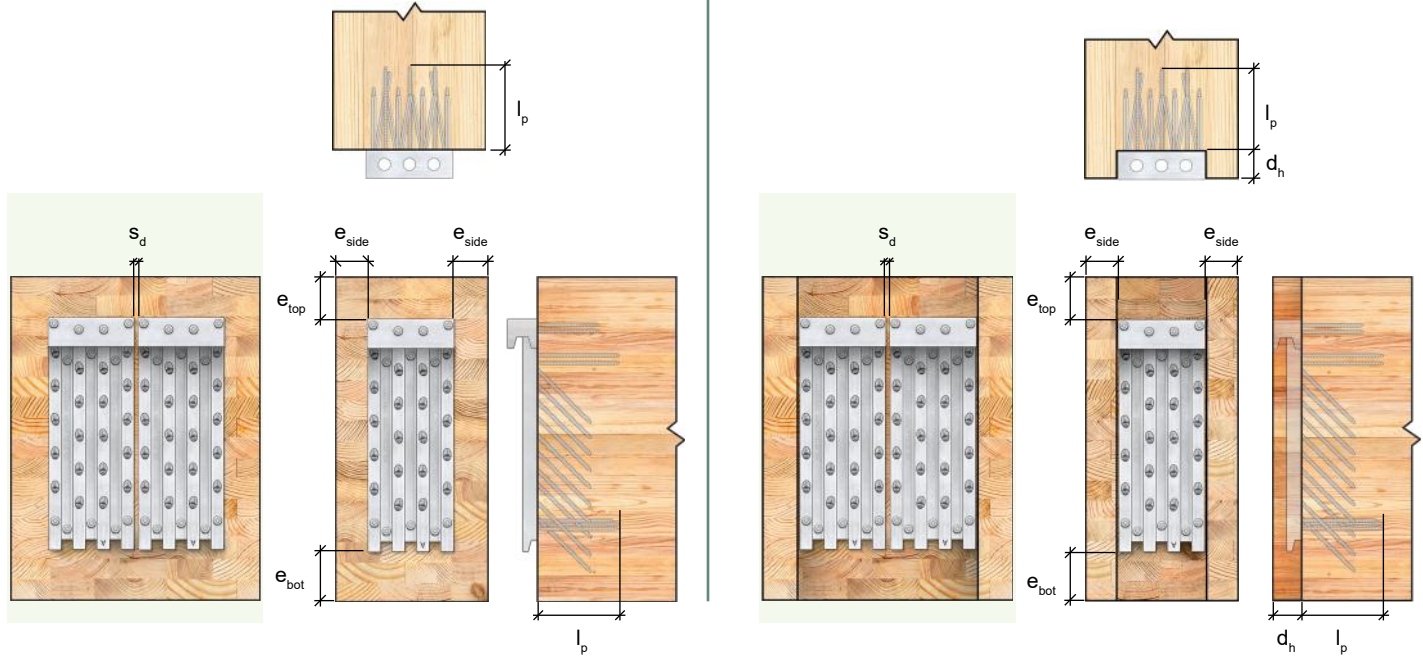

Table 3.12 - MEGANT 150 Geometry Requirements for Secondary Member

MEGANT 150		Geometry Requirements [in.]									
		l_p	e_{top}	No FRR		1-hr FRR		2-hr FRR		d_h	s_d
				e_{side}	e_{bot}	e_{side}	e_{bot}	e_{side}	e_{bot}		
Model	Configuration										
MEGANT 310 x 150	Single	5-25/32	1-13/16	9/16	1-31/32	1-23/32	3-13/32	3	5-3/32	1-15/16	N/A
	Double	5-25/32	1-13/16	9/16	1-31/32	1-23/32	3-13/32	3	5-3/32	1-15/16	5/32
MEGANT 430 x 150	Single	5-25/32	1-13/16	9/16	1-31/32	1-23/32	3-13/32	3	5-3/32	1-15/16	N/A
	Double	5-25/32	1-13/16	9/16	1-31/32	1-23/32	3-13/32	3	5-3/32	1-15/16	5/32
MEGANT 550 x 150	Single	5-25/32	1-13/16	9/16	1-31/32	1-23/32	3-13/32	3	5-3/32	1-15/16	N/A
	Double	5-25/32	1-13/16	9/16	1-31/32	1-23/32	3-13/32	3	5-3/32	1-15/16	5/32
MEGANT 730 x 150	Single	5-25/32	1-13/16	9/16	1-31/32	1-23/32	3-13/32	3	5-3/32	1-15/16	N/A
	Double	5-25/32	1-13/16	9/16	1-31/32	1-23/32	3-13/32	3	5-3/32	1-15/16	5/32

Notes:

1. Connection design must meet all relevant requirements of the General Notes to the Designer section.
2. Screw installation must follow the patterns presented in the Installation section.
3. Tabulated values presented are minimum requirements unless noted otherwise. Tabulated values for l_p are fixed. Tabulated values for d_h are maximum values based on a gap of 0.039 in. [1 mm] between the primary and secondary member. Larger gaps (such as a typical gap of 1/8 in.) will reduce d_h accordingly.
4. Tabulated values that are not dependent on FRR, as well as those for secondary beams with no FRR, are based on minimum end and edge distances.
5. Minimum dimensions for beams with an FRR are based on minimum wood cover requirements specified in NDS 2024 Chapter 16.5. Beam sizes satisfying an FRR assume a fire-resistant joint compliant with FDS 2024 Section 2.5.1.3. and that any void below the connector in the routing has been sealed with a wood plug. The tip of the inclined screws are permitted to penetrate the minimum wood cover.
6. Dimensions for 1-hr and 2-hr FRRs are based on the unthreaded jaw being installed on top, with the threaded rod and nut being installed from above as shown in the examples above.

Primary Member Geometry Requirements - Beam/Girder



Unhoused

Housed

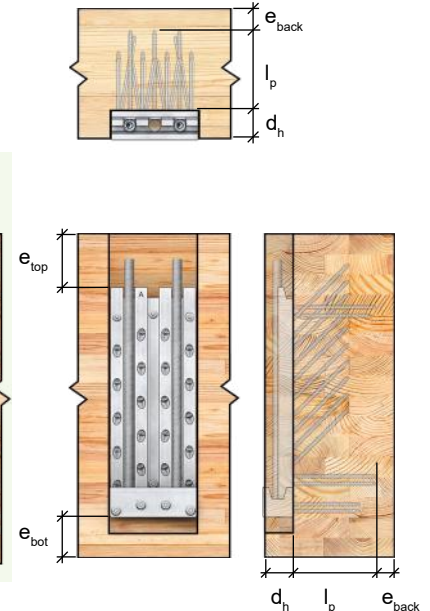
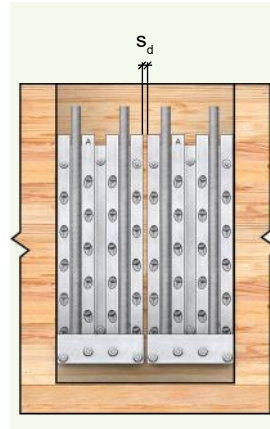
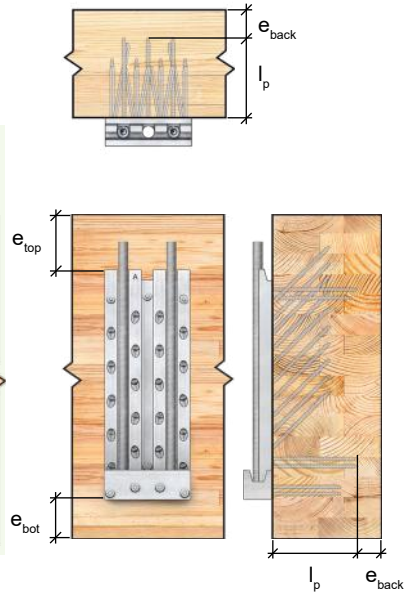
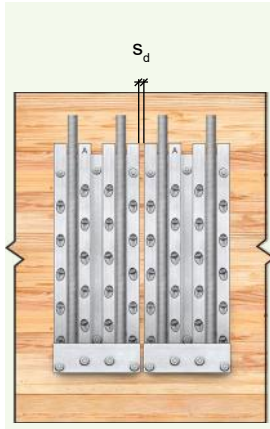

Table 3.13 - MEGANT 150 Geometry Requirements for Primary Member (Beam/Girder)

MEGANT 150		Geometry Requirements [in.]									
Model	Configuration	l_p	e_{top}	No FRR		1-hr FRR		2-hr FRR		d_h	s_d
				e_{bot}	e_{back}	e_{bot}	e_{back}	e_{bot}	e_{back}		
MEGANT 310 x 150	Single	5-25/32	3	1-13/16	13/32	2-1/4	1-23/32	3-15/16	3	1-15/16	N/A
	Double	5-25/32	3	1-13/16	13/32	2-1/4	1-23/32	3-15/16	3	1-15/16	5/32
MEGANT 430 x 150	Single	5-25/32	3	1-13/16	13/32	2-1/4	1-23/32	3-15/16	3	1-15/16	N/A
	Double	5-25/32	3	1-13/16	13/32	2-1/4	1-23/32	3-15/16	3	1-15/16	5/32
MEGANT 550 x 150	Single	5-25/32	3	1-13/16	13/32	2-1/4	1-23/32	3-15/16	3	1-15/16	N/A
	Double	5-25/32	3	1-13/16	13/32	2-1/4	1-23/32	3-15/16	3	1-15/16	5/32
MEGANT 730 x 150	Single	5-25/32	3	1-13/16	13/32	2-1/4	1-23/32	3-15/16	3	1-15/16	N/A
	Double	5-25/32	3	1-13/16	13/32	2-1/4	1-23/32	3-15/16	3	1-15/16	5/32

Notes:

1. Connection design must meet all relevant requirements of the General Notes to the Designer section.
2. Screw installation must follow the patterns presented in the Installation section.
3. Tabulated values presented are minimum requirements unless noted otherwise. Tabulated values for l_p are fixed. Tabulated values for d_h are maximum values based on a gap of 0.039 in. [1 mm] between the primary and secondary member. Larger gaps (such as a typical gap of 1/8 in.) will reduce d_h accordingly.
4. Tabulated values that are not dependent on FRR, as well as those for primary beams with no FRR, are based on minimum end and edge distances.
5. Minimum dimensions for beams with an FRR are based on minimum wood cover requirements specified in NDS 2024 Chapter 16.5. Beam sizes satisfying an FRR assume a fire-resistant joint compliant with FDS 2024 Section 2.5.1.3. and that any void below the connector in the routing has been sealed with a wood plug. The tip of the inclined screws are permitted to penetrate the minimum wood cover.
6. Values for e_{top} are minimum requirements based on minimum end and edge distance, and may need to be adjusted to align with the hanger placement in the secondary beam.
7. Dimensions for 1-hr and 2-hr FRRs are based on the threaded jaw being installed on the bottom, with the threaded rod and nut being installed from above as shown in the examples above.

Primary Member Geometry Requirements - Column



Unhoused

Housed

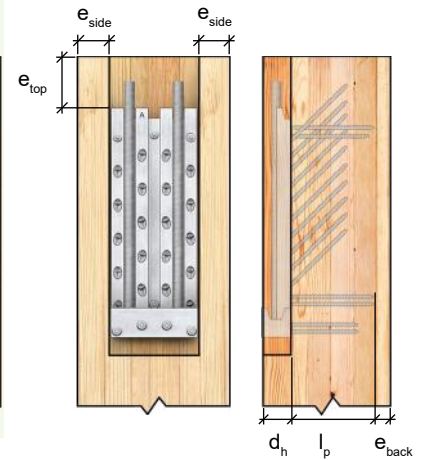
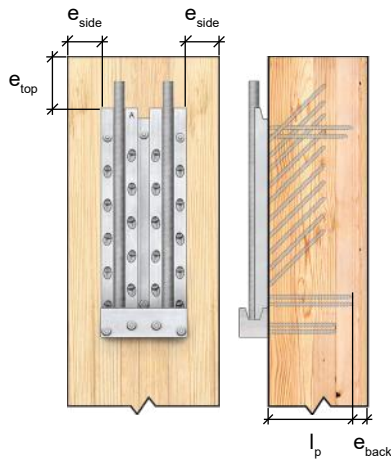
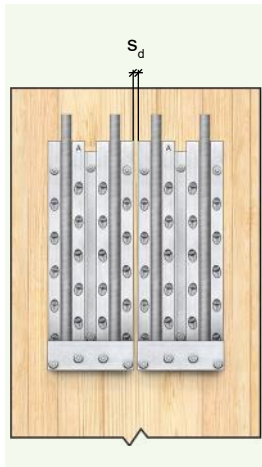
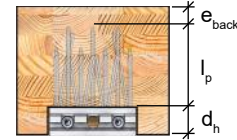
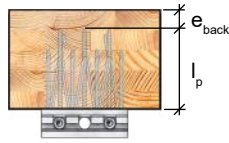

Table 3.14 - MEGANT 150 Geometry Requirements for Primary Member (Column)

MEGANT 150		Geometry Requirements [in.]									
		l _p	e _{top}	No FRR		1-hr FRR		2-hr FRR		d _h	s _d
				e _{side}	e _{back}	e _{side}	e _{back}	e _{side}	e _{back}		
MEGANT 310 x 150	Single	5-25/32	3	9/16	13/32	1-23/32	1-23/32	3	3	1-15/16	N/A
	Double	5-25/32	3	9/16	13/32	1-23/32	1-23/32	3	3	1-15/16	5/32
MEGANT 430 x 150	Single	5-25/32	3	9/16	13/32	1-23/32	1-23/32	3	3	1-15/16	N/A
	Double	5-25/32	3	9/16	13/32	1-23/32	1-23/32	3	3	1-15/16	5/32
MEGANT 550 x 150	Single	5-25/32	3	9/16	13/32	1-23/32	1-23/32	3	3	1-15/16	N/A
	Double	5-25/32	3	9/16	13/32	1-23/32	1-23/32	3	3	1-15/16	5/32
MEGANT 730 x 150	Single	5-25/32	3	9/16	13/32	1-23/32	1-23/32	3	3	1-15/16	N/A
	Double	5-25/32	3	9/16	13/32	1-23/32	1-23/32	3	3	1-15/16	5/32

Notes:

1. Connection design must meet all relevant requirements of the General Notes to the Designer section.
2. Screw installation must follow the patterns presented in the Installation section.
3. Tabulated values presented are minimum requirements unless noted otherwise. Tabulated values for l_p are fixed. Tabulated values for d_h are maximum values based on a gap of 0.039 in. [1 mm] between the primary and secondary member. Larger gaps (such as a typical gap of 1/8 in.) will reduce d_h accordingly.
4. Tabulated values that are not dependent on FRR, as well as those for columns with no FRR, are based on minimum end and edge distances.
5. Minimum dimensions for columns with an FRR are based on minimum wood cover requirements specified in NDS 2024 Chapter 16.5. Column sizes satisfying an FRR assume a fire-resistant joint compliant with FDS 2024 Section 2.5.1.3. and that any void below the connector in the routing has been sealed with a wood plug. The tip of the inclined screws are permitted to penetrate the minimum wood cover.
6. Values for e_{top} are minimum requirements based on minimum end and edge distance, and may need to be adjusted to align with the hanger placement in the secondary beam.
7. Dimensions for 1-hr and 2-hr FRRs are based on the threaded jaw being installed on the bottom, with the threaded rod and nut being installed from above as shown in the examples above.

Additional Detailing Considerations

Geometry Requirements for Columns with Multiple Beam Hangers

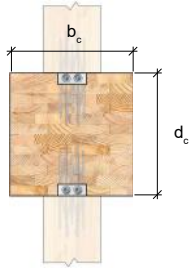

Hangers on Opposing Faces of a Square Column

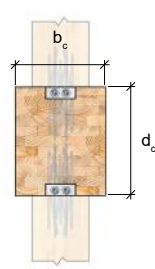

Hangers on Opposing Faces of a Rectangular Column

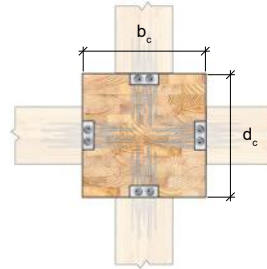

Hanger on Each Face of a Square Column

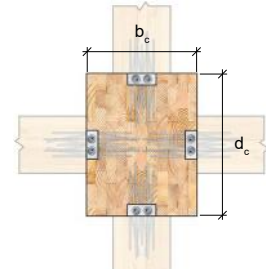

Hanger on Each Face of a Rectangular Column

Table 3.15 - Minimum Column Sizes for Multiple MEGANT Connectors

Model	Minimum Column Section Dimensions, $b_c \times d_c$ [in. x in.]					
	Hangers on Opposing Faces of a Square Column			Hangers on Opposing Faces of a Rectangular Column		
	No FRR	1-hr FRR	2-hr FRR	No FRR	1-hr FRR	2-hr FRR
MEGANT 60 Series	15-17/32 x 15-17/32	15-17/32 x 15-17/32	15-17/32 x 15-17/32	3-15/32 x 15-17/32	5-25/32 x 15-17/32	8-3/8 x 15-17/32
MEGANT 100 Series	15-17/32 x 15-17/32	15-17/32 x 15-17/32	15-17/32 x 15-17/32	5-1/32 x 15-17/32	7-11/32 x 15-17/32	9-15/16 x 15-17/32
MEGANT 150 Series	15-15/16 x 15-15/16	15-15/16 x 15-15/16	15-15/16 x 15-15/16	7 x 15-15/16	9-5/16 x 15-15/16	11-29/32 x 15-15/16

Model	Minimum Column Section Dimensions, $b_c \times d_c$ [in. x in.]					
	Hanger on Each Face of a Square Column			Hangers on Each Face of a Rectangular Column		
	No FRR	1-hr FRR	2-hr FRR	No FRR	1-hr FRR	2-hr FRR
MEGANT 60 Series	15-3/4 x 15-3/4	15-3/4 x 15-3/4	15-3/4 x 15-3/4	15-17/32 x 15-29/32	15-17/32 x 15-29/32	15-17/32 x 15-29/32
MEGANT 100 Series	17-5/16 x 17-5/16	17-5/16 x 17-5/16	17-5/16 x 17-5/16	15-17/32 x 17-5/8	15-17/32 x 17-5/8	15-17/32 x 17-5/8
MEGANT 150 Series	19-17/32 x 19-17/32	19-17/32 x 19-17/32	19-17/32 x 19-17/32	15-15/16 x 21-13/16	15-15/16 x 21-13/16	15-15/16 x 21-13/16

Notes:

1. Tabulated column section dimensions are minimum values based on a 1/2 in. clearance between screw tips, minimum edge and end distances, and minimum wood cover requirements for FRR. Refer to Geometry Requirements for further details.
2. It is the responsibility of the EOR to ensure the primary and secondary members have adequate capacity to resist connection forces.
3. Tabulated column section dimensions assume hangers are centered within each column face and are housed in the column as shown.

Hanger Placement Considerations

The hanger placement relative to the height of the beam can impact the need for reinforcement. Connectors in the primary member should have the tip of the uppermost fastener in the top 30% of the member depth (0.3d), as shown in the bottom left figure. Connectors in the secondary member should have the tip of the lowermost fastener in the bottom 30% (0.3d), as shown in the bottom right figure. Outside of these zones, the primary and secondary members should be checked for splitting to determine if reinforcement is required. For further information, refer to Appendix C: Survey of Literature on Reinforcement for Tension Perpendicular to Grain (Page 100).

Model	d_t	d_b
	in.	
MEGANT 310 x 60	2-3/4	2-3/4
MEGANT 430 x 60	2-3/4	2-3/4
MEGANT 550 x 60	2-3/4	2-3/4
MEGANT 310 x 100	1-9/16	1-9/16
MEGANT 430 x 100	1-9/16	1-9/16
MEGANT 550 x 100	1-9/16	1-9/16
MEGANT 310 x 150	1-9/16	1-9/16
MEGANT 430 x 150	1-9/16	1-9/16
MEGANT 550 x 150	1-9/16	1-9/16
MEGANT 730 x 150	1-3/32	1-3/32

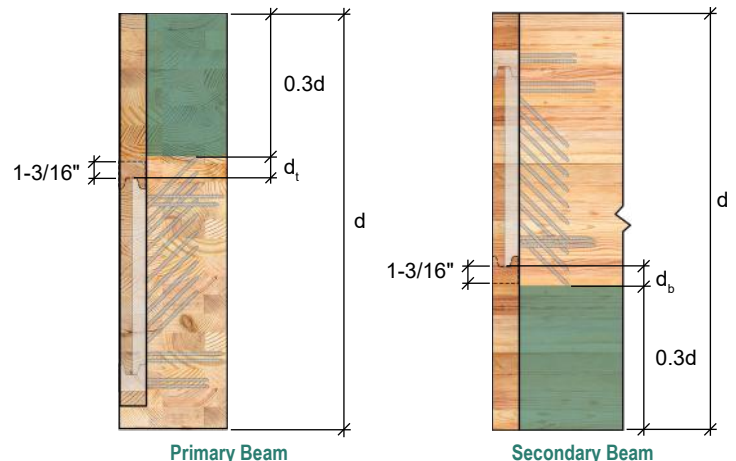

Housing Details

Housing Possibilities

Primary Beam Housing

- Most common housing for concealed installation.
- Concealed from below, the rod(s) can be installed from the top down.

Secondary Beam Housing

- Joist housing from bottom up.
- Concealed from below with a wood plug, requiring the rod(s) to be installed from bottom up.

Secondary Beam Through Housing

- Full-depth housing in joist.
- Concealed from below with a wood plug, the rod(s) can still be installed from the top.

Secondary Beam Top Housing

- Joist housing from top down. Concealed from below. No wood plug required.
- Threaded rod(s) can be installed from top down.



Housing and Surface Detailing

Parallel Surface: The members must be parallel at the location of the connection to ensure proper hanger alignment and load transfer.

Gap Size: The gap size between wood members balances installation ease and fire performance, with larger gaps simplifying installation but reducing fire protection. The gap is typically sized at 1/8 in. [3.2 mm] to address fire protection considerations as outlined in FDS 2024 [refer to Appendix A: Fire Protection (Page 92)]. For proper installation, a minimum gap of 0.039 in. [1 mm] is required to allow the secondary member to slide into place.

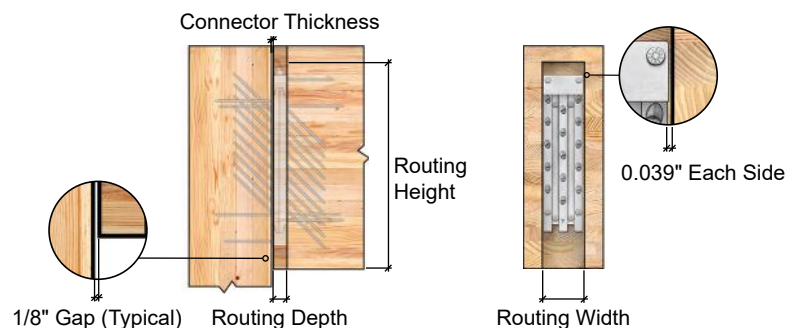

Routing Depth: The routing depth is the depth of the housing, d_h , noted in the Geometry Requirements and Housing Dimensions sections. This depth takes into account the thickness of the connector and the gap between members (assumed as 0.039 in. [1 mm] herein - larger gaps will reduce d_h accordingly).

Routing Width: It is recommended to allow a clearance of 0.039 in. [1 mm] on each side of the connector:

- MEGANT 60 Series: 2.441 in. [62 mm]
- MEGANT 100 Series: 4.016 in. [102 mm]
- MEGANT 150 Series: 5.984 in. [152 mm]

Routing Height: The routing height must be coordinated with the EOR. The height of the connector in the beam section has an impact on connector performance. Refer to the Hanger Placement Considerations section (Page 75) for further information.

Housing Dimensions

Routing in Primary Member

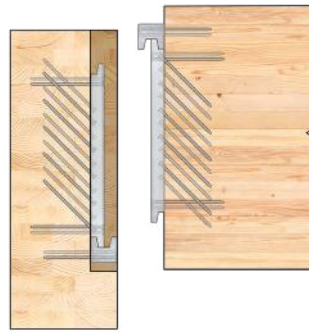

Fastener Orientation

- Structural Positioning Screws
(Refer to Fastener Layout on Page 80)

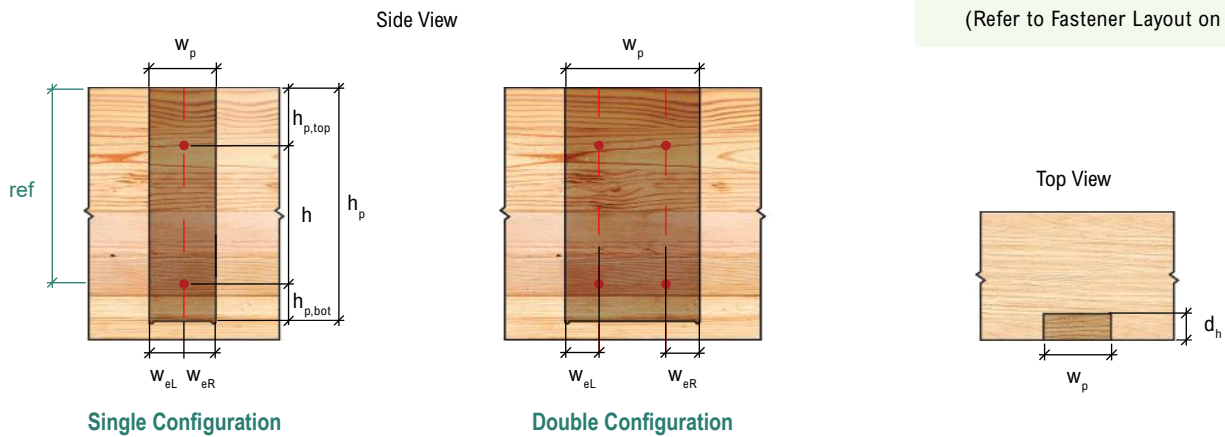

Table 3.16 - Routing Dimensions for MEGANT Housed in Primary Member

Model	Routing Dimensions, in. [mm]								
	h_p	$h_{p,top}$	h	$h_{p,bot}$	w_p		w_{eL}	w_{eR}	d_h
					Single	Double			
MEGANT 310 x 60	15.079 [383]	4.724 [119]	6.693 [170]	3.622 [92]	2.441 [62]	5.118 [130]	1.220 [31]	1.220 [31]	1.535 [39]
MEGANT 430 x 60	19.803 [503]	4.724 [119]	11.417 [290]	3.622 [92]	2.441 [62]	5.118 [130]	1.220 [31]	1.220 [31]	1.535 [39]
MEGANT 550 x 60	24.528 [623]	4.724 [119]	16.142 [410]	3.622 [92]	2.441 [62]	5.118 [130]	1.220 [31]	1.220 [31]	1.535 [39]
MEGANT 310 x 100	14.921 [379]	4.370 [121]	6.693 [170]	3.819 [97]	4.016 [102]	8.268 [210]	1.220 [31]	2.795 [71]	1.535 [39]
MEGANT 430 x 100	19.646 [499]	4.370 [121]	11.417 [290]	3.819 [97]	4.016 [102]	8.268 [210]	1.220 [31]	2.795 [71]	1.535 [39]
MEGANT 550 x 100	24.370 [619]	4.370 [121]	16.142 [410]	3.819 [97]	4.016 [102]	8.268 [210]	1.220 [31]	2.795 [71]	1.535 [39]
MEGANT 310 x 150	14.921 [379]	4.764 [121]	6.693 [170]	3.425 [87]	5.984 [152]	12.205 [310]	2.992 [76]	2.992 [76]	1.929 [49]
MEGANT 430 x 150	19.646 [499]	4.764 [121]	11.417 [290]	3.425 [87]	5.984 [152]	12.205 [310]	2.992 [76]	2.992 [76]	1.929 [49]
MEGANT 550 x 150	24.370 [619]	4.764 [121]	16.142 [410]	3.425 [87]	5.984 [152]	12.205 [310]	2.992 [76]	2.992 [76]	1.929 [49]
MEGANT 730 x 150	31.457 [799]	4.764 [121]	23.228 [590]	3.425 [87]	5.984 [152]	12.205 [310]	2.992 [76]	2.992 [76]	1.929 [49]

Notes:

1. Tabulated values are general guidelines for routing requirements. The EOR and fabricator are responsible for ensuring final routing dimensions account for all project-specific conditions.
2. Tabulated values are minimum requirements unless noted otherwise. Tabulated values for h are fixed. Tabulated values for d_h are maximum allowable.
3. Tabulated values for w_p , w_{eL} , and w_{eR} account for 0.039 in. [1 mm] on each side of the hanger. Larger installation tolerances will increase width values accordingly.
4. Tabulated values are based on a gap of 0.039 in. [1 mm] between the primary and secondary member. Larger gaps (such as a typical gap of 1/8 in.) will reduce d_h accordingly.
5. Tabulated values for h_p , $h_{p,top}$, and $h_{p,bot}$ account for a 0.866 in. [22 mm] gap below the clamping jaw and an additional 1.181 in. [30 mm] above the connector for the nut assembly to allow for proper installation. The resulting hidden void should be protected from fire using industry-approved methods. Larger installation tolerances will increase height measurements accordingly.
6. Tabulated values assume square corners. Manufacturers should adjust the tabulated values based on their specific routing bit sizes. In order to account for the round corner created by routing tools, 1/4 in. overrun is permitted at the inside corners as indicated on the image above.
7. Refer to the Geometry Requirements tables for each respective beam hanger for additional information.

Routing in Secondary Member

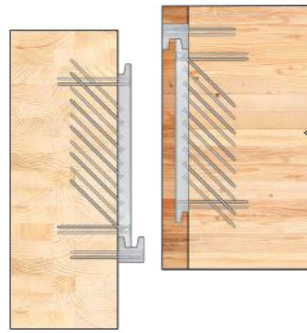

Fastener Orientation
 ● Structural Positioning Screws
 (Refer to Fastener Layout on Page 80)

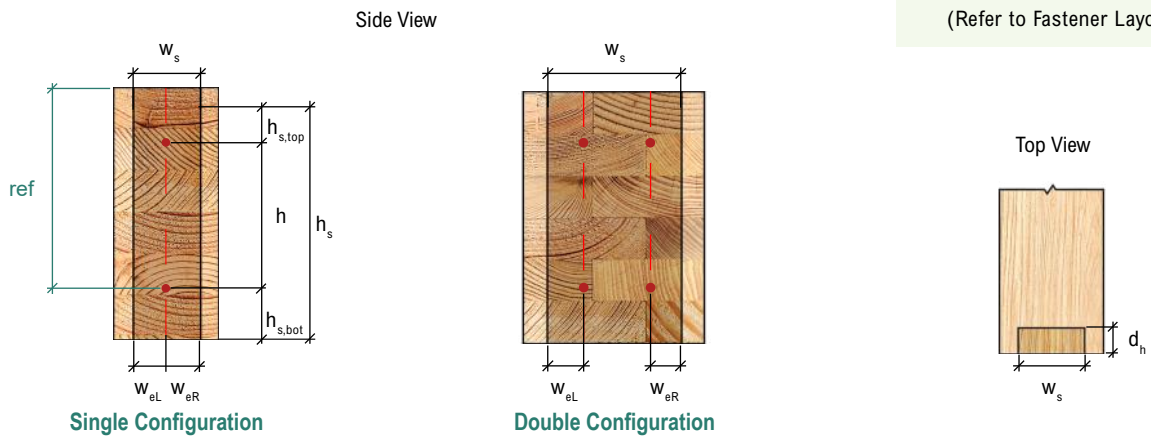

Table 3.17 - Routing Dimensions for MEGANT Housed in Secondary Member (Beam-End)

Model	Routing Dimensions, in. [mm]								
	h_s	$h_{s,top}$	h	$h_{s,bot}$	w_s		w_{eL}	w_{eR}	d_h
					Single	Double			
MEGANT 310 x 60	15.079 [383]	4.724 [120]	6.693 [170]	4.724 [120]	2.441 [62]	5.118 [130]	1.220 [31]	1.220 [31]	1.535 [39]
MEGANT 430 x 60	19.803 [503]	4.724 [120]	11.417 [290]	4.724 [120]	2.441 [62]	5.118 [130]	1.220 [31]	1.220 [31]	1.535 [39]
MEGANT 550 x 60	24.528 [623]	4.724 [120]	16.142 [410]	4.724 [120]	2.441 [62]	5.118 [130]	1.220 [31]	1.220 [31]	1.535 [39]
MEGANT 310 x 100	14.921 [379]	4.764 [121]	6.693 [170]	3.346 [85]	4.016 [102]	8.268 [210]	1.220 [31]	2.795 [71]	1.535 [39]
MEGANT 430 x 100	19.646 [499]	4.764 [121]	11.417 [290]	3.346 [85]	4.016 [102]	8.268 [210]	1.220 [31]	2.795 [71]	1.535 [39]
MEGANT 550 x 100	24.370 [619]	4.764 [121]	16.142 [410]	3.346 [85]	4.016 [102]	8.268 [210]	1.220 [31]	2.795 [71]	1.535 [39]
MEGANT 310 x 150	14.921 [379]	4.370 [111]	6.693 [170]	3.740 [95]	5.984 [152]	12.205 [310]	2.992 [76]	2.992 [76]	1.929 [49]
MEGANT 430 x 150	19.646 [499]	4.370 [111]	11.417 [290]	3.740 [95]	5.984 [152]	12.205 [310]	2.992 [76]	2.992 [76]	1.929 [49]
MEGANT 550 x 150	24.370 [619]	4.370 [111]	16.142 [410]	3.740 [95]	5.984 [152]	12.205 [310]	2.992 [76]	2.992 [76]	1.929 [49]
MEGANT 730 x 150	31.457 [799]	4.370 [111]	23.228 [590]	3.346 [85]	5.984 [152]	12.205 [310]	2.992 [76]	2.992 [76]	1.929 [49]

Notes:

1. Tabulated values are general guidelines for routing requirements. The EOR and fabricator are responsible for ensuring final routing dimensions account for all project-specific conditions.
2. Tabulated values are minimum requirements unless noted otherwise. Tabulated values for h are fixed. Tabulated values for d_h are maximum allowable.
3. Tabulated values for w_s , w_{eL} , and w_{eR} account for 0.039 in. [1 mm] on each side of the hanger. Larger installation tolerances will increase width values accordingly.
4. Tabulated values are based on a gap of 0.039 in. [1 mm] between the primary and secondary member. Larger gaps (such as a typical gap of 1/8 in.) will reduce d_h accordingly.
5. Tabulated values for h_s , $h_{s,top}$, and $h_{s,bot}$ account for a 0.866 in. [22 mm] gap below the clamping jaw and an additional 1.181 in. [30 mm] above the connector for the nut assembly to allow for proper installation. The resulting hidden void should be protected from fire using industry-approved methods. Larger installation tolerances will increase height measurements accordingly.
6. Tabulated values assume square corners. Manufacturers should adjust the tabulated values based on their specific routing bit sizes in order to account for the round corner created by routing tools, 1/4 in. overrun is permitted at the inside corners as indicated on the image above.
7. Refer to the Geometry Requirements tables for each respective beam hanger for additional information.

MEGANT Installation Configurations

Possible Installation Configuration for MEGANT

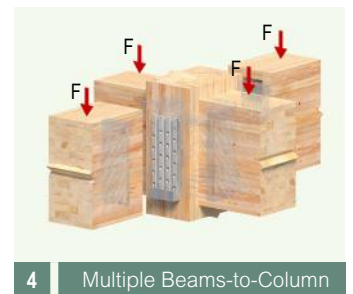
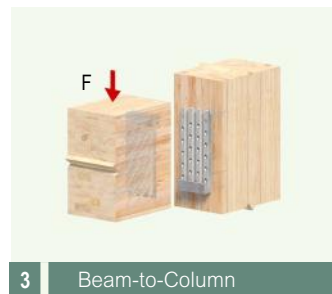
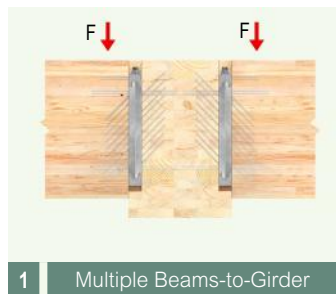
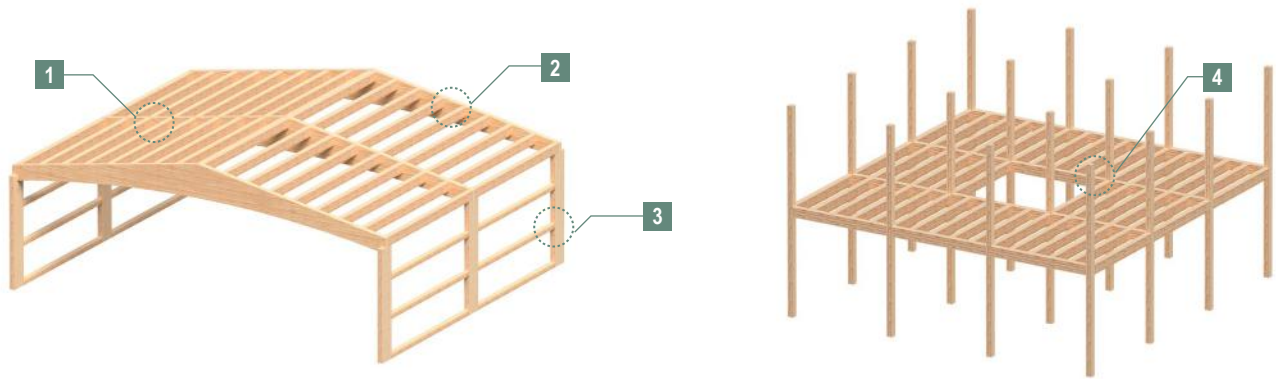

Alternative Ways to Connect

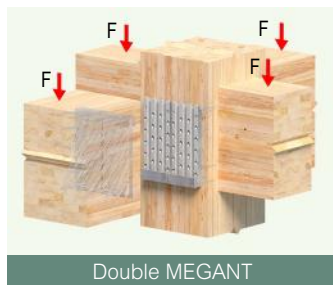

Beam Length Tolerances and Sequencing

Installation sequencing is important, especially for buildings with multiple bays of post-and-beam framing. It is recommended to install the beams starting from one end of the building and progressing along the column line. The last beam can be produced slightly over length and cut to size on-site to help mitigate any dimensional tolerance challenges. The MEGANT can be installed from above, below, or either side.

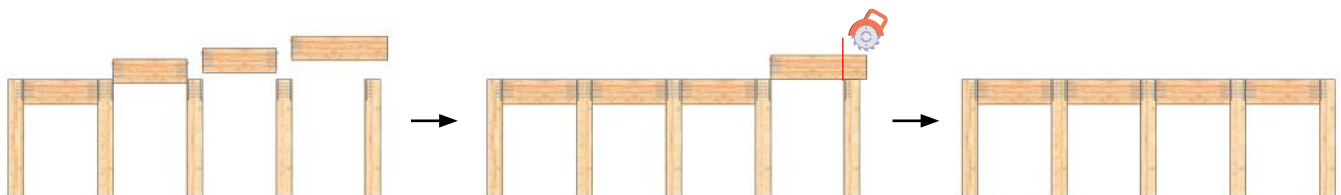

MEGANT Installation Procedure

Tool Requirements

Tools - Use the Correct Bit

MTC Solutions fasteners should only be driven using either RW bits or appropriately sized star bits. This ensures good centering and positioning with optimal torque transmission. For the MEGANT, use an RW 40 bit for 5/16 in. CSK screws.



RW 40

Tools - Use the Correct Drill

Use low-RPM, high-torque drills equipped with a feather (variable speed) trigger to install fasteners. Avoid excessive acceleration and deceleration during the drive-in process. Do not overtorque fasteners. Although impact guns are not expressly prohibited, their use is discouraged - particularly for beam hanger systems - due to an increased risk of overtightening. Use the appropriate drill chuck size according to the fastener.

Table 3.18 - Recommended Torque, Drill Bits, and Power Drill

Nominal Fastener Diameter [D]		HSS Drill Bit Size	Power Drill Voltage	Allowable Insertion Torque
in.	[mm]	in.	V	lb. · ft.
5/16	[8]	3/16	20	12.3

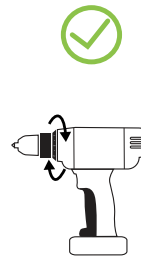

Cordless Clutched Drill

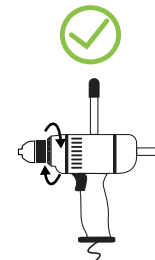

Double Handle Drill

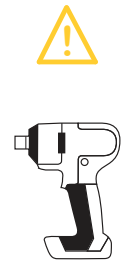

Impact Drill

Tools - Predrilling Jig 3/16 in.

The Predrilling Jig ensures precise alignment of the MEGANT 45° inclined fasteners. It guides the drill bit to create accurate pilot holes, and ensures proper fastener seating. The hole in the jig accommodates imperial and metric drill bit diameters. For the 5/16 in. inclined fasteners, pilot holes 3/16 in. in diameter and 1 in. long are recommended.

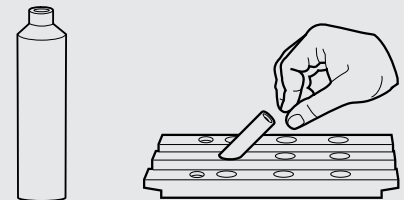

Predrilling Jig 3/16"

Fastener Layout

Fastener Orientation

- Structural Positioning Screws
- Horizontal Screws
- Inclined Screws

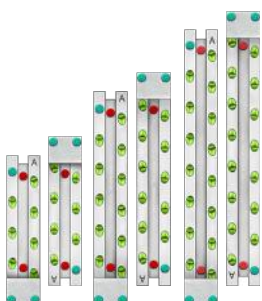

MEGANT 60 Series

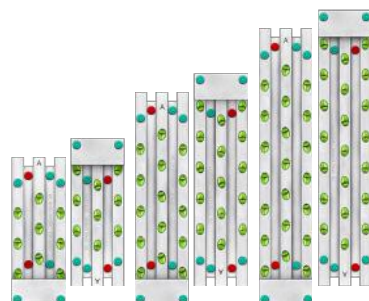

MEGANT 100 Series

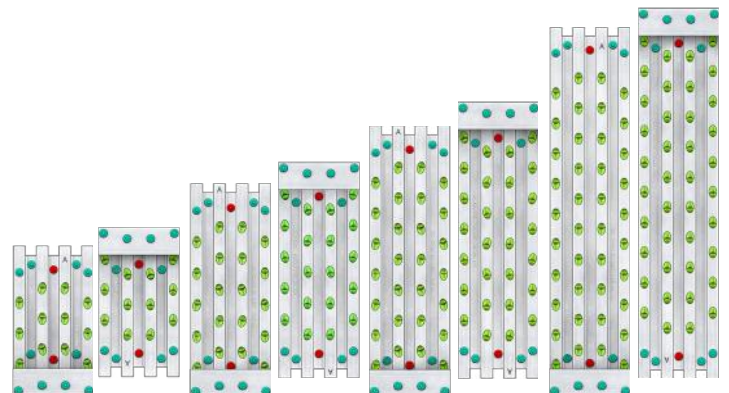

MEGANT 150 Series

General Installation Steps

Estimated Installation Time

The estimated installation time for a single person to install a complete MEGANT product is shown in Table 3.19.

This process includes the following steps:

1. Layout (~5-10%)
2. Positioning (~5-15%)
3. Pilot Holes (~20-30%)
4. Screw Installation (~40-50%)
5. Clamping Jaw Installation (~15-25%)
6. Optional Measures (not included in the time installation % breakdown)

Table 3.19 - MEGANT Estimated Installation Times

Megant Model	Average Installation Time [min.]	Megant Model	Average Installation Time [min.]
310 x 60	17	310 x 150	31
430 x 60	21	430 x 150	37
550 x 60	24	550 x 150	44
310 x 100	23	730 x 150	53
430 x 100	27		
550 x 100	32		

The estimated time can be improved upon with efficient fabrication and site practices such as:

1. Drilling pilot holes for the structural positioning screws at the time of fabrication
2. Utilizing templates to drill pilot holes for structural screws
3. Optimizing beam positioning to reduce work fatigue

Step-by-Step Installation Guidelines

1.1 Layout - Reference Points

Begin by laying out the locations of the beam hanger on the primary and secondary members using a pencil and square. Position the MEGANT's plates for installation, ensuring the proper orientation is set on both the primary and secondary members. Each MEGANT plate is marked with an "A" on one end and a "B" on the opposite end.

- The "A" shall be oriented towards the top of the primary member
- The "B" shall be oriented towards the top of the secondary member

Note: When the inclined screws are installed, they will incline towards the end of the plate marked with an "A". It is critical to lay the pieces out in the correct orientation on both members, as the capacity of the hanger is dependent on the withdrawal of the fasteners in this orientation.

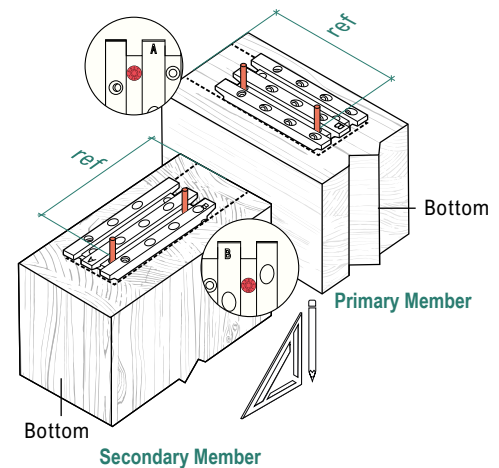

1.2 Layout - Split Lamination Considerations

It is recommended that vertical joints in split lamination glulam beams be tight at the time of manufacturing. Gaps between adjacent plies may occur due to wood shrinkage. Gaps up to 1/8 in. are acceptable for typical MEGANT installation.

If split lamination gaps greater than 1/8 in. exist in the beam-end an alternative screw pattern will be required

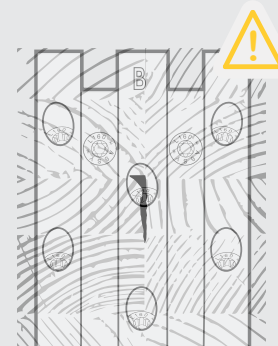

2.1 Positioning - Structural Positioning Screw Installation

Positioning screws ensure accurate placement of the MEGANT connector. To facilitate accuracy and installation time, it is recommended to predrill the structural positioning screw locations during member fabrication. Note that structural screws cannot be reused if the connector requires adjustment. Install one structural positioning screw into the hole highlighted at the top of the plate. Check to ensure alignment is maintained, and then install the second structural positioning screw into the hole highlighted at the bottom of the plate.

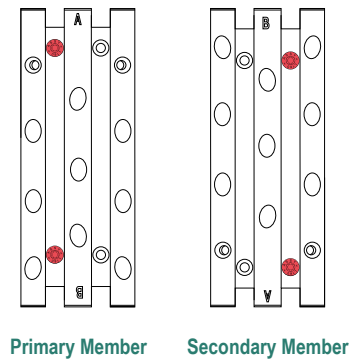

3.1 Pilot Holes - Recommendations

Pilot holes are optional; however, they allow for faster screw thread engagement, help reduce splitting risks, ensure a proper penetration path which reduces screw wandering, and reduce insertion torque. For the structural fasteners used with the MEGANT series, pilot holes 3/16 in. in diameter and 1 in. in length are recommended. The use of MTC Predrilling Jig for the inclined screws is recommended to ensure proper hole placement.

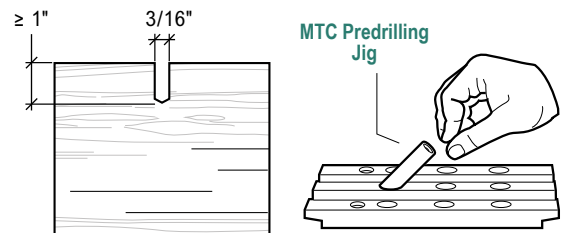

4.1 Screw Installation - Align Drill Bit Axis

Align the drill bit axis parallel to the fastener axis during installation to allow proper torque transmission and to avoid stripping.

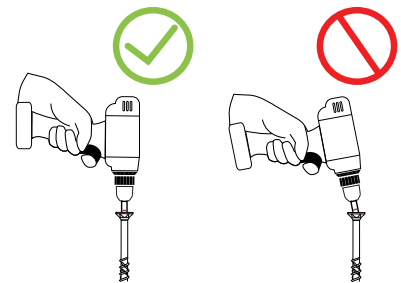

4.2 Screw Installation - Decrease RPM

To avoid overtorquing the screw, decrease the rotation speed about 1/2 in. away from the final installed position. This is crucial to prevent wood crushing due to overtorquing, which can impact beam hanger tolerances, potentially impeding overall connection assembly. This is especially important when using an impact drill.

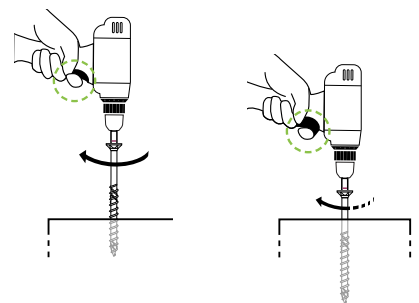

4.3 Screw Installation - Drill Pressure

Do not apply excessive pressure on the drill while driving the fastener to prevent fastener buckling or deviation during installation. Only apply the required force or use the recommended holder case to eliminate cam-out effects.

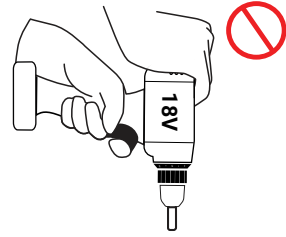

4.4 Screw Installation - One-Step Process

To avoid increased torque peaks caused by stopping and restarting the drive-in process, install the screw in one run until the head is lightly seated against the side member. If necessary, a torque wrench may be used to complete installation immediately after the screw has been driven.

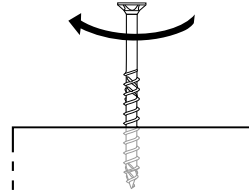

4.5 Screw Installation - Remaining Shear Screws

Install 5/16" x 6-1/4" VG CSK screws in the remaining horizontal holes, beginning adjacent to the structural positioning screws.

Note that some of the horizontal screws are angled inward by 15°.

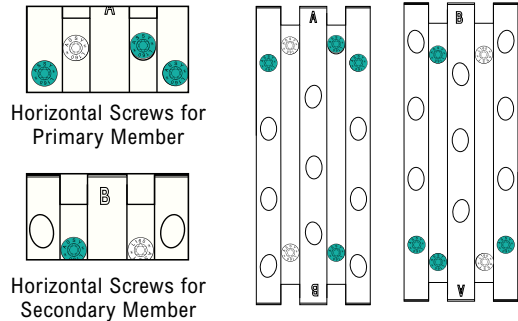

4.6 Screw Installation - Inclined Screws

Install 5/16" x 6-1/4" VG CSK screws in all inclined holes after all perpendicular screws have been installed.

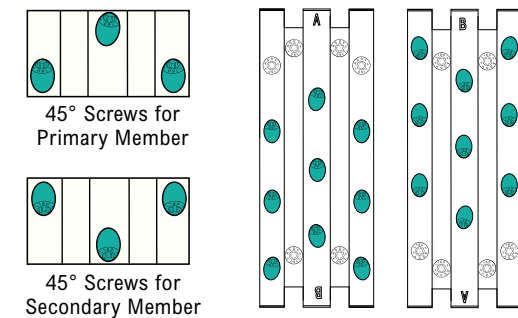

5.1 Clamping Jaws - General Information

Clamping jaws should be installed on each end of the connector plates with the countersunk holes facing away from the beam. Each MEGANT product kit comes with:

- One clamping jaw with threaded holes
- One clamping jaw with smooth/unthreaded holes

The threaded rods, without tightening, may be used to ensure both jaws are correctly positioned.

The unthreaded clamping jaw must remain accessible for tightening the connector plates together.

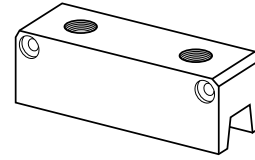

Threaded Clamping Jaw

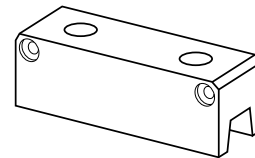

Unthreaded Clamping Jaw

Drop-down Installation

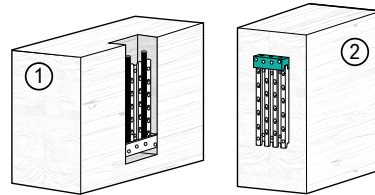
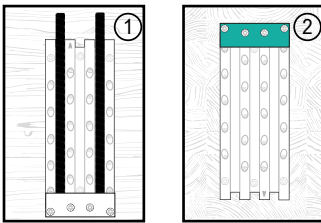

Primary Member Housing

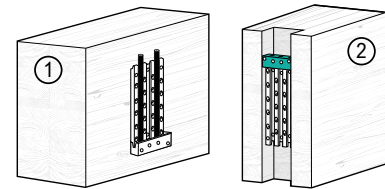

Secondary Member Through Housing

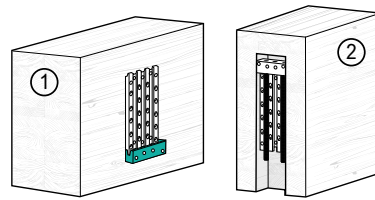
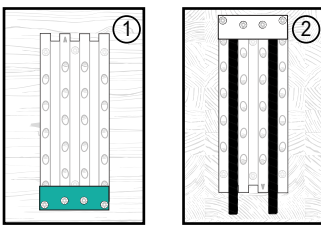

Secondary Member Bottom Housing

- Unthreaded Clamping Jaw
- ① Primary Member
- ② Secondary Member

Notes:

1. With through housing, the unthreaded jaw can be at either the top or bottom depending on access

Bottom-up Installation

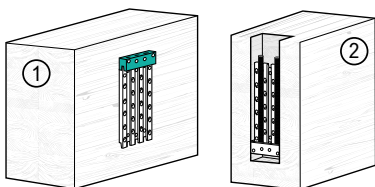
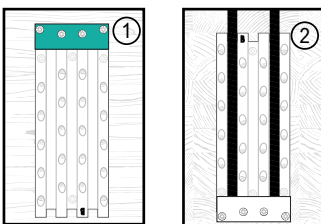

Secondary Member Top Housing

5.2 Clamping Jaws - Threaded Jaw Installation

Install the threaded clamping jaw on the housed member at the closed end with the grooved side seated firmly against the tongue of the connector plate. Insert the threaded rod(s) to help position the jaw on the connector plate.

Drill 3/16 in. x 1 in. pilot holes at the jaw screw locations, and then install VG CSK screws to secure the clamping jaw. Remove the threaded rod(s) and retain them for Step 5.3.

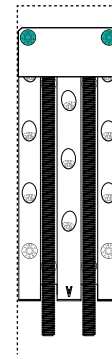

Secondary Member
Bottom Housing
Example

Clamping Jaw Screws, Secondary Member

5.3 Clamping Jaws - Unthreaded Jaw Installation

Install the unthreaded clamping jaw on the unhoused member at the same plate label (i.e., both jaws will be installed on either "A" end or "B" end). Insert the threaded rod(s) to help position the jaw on the connector plate.

Drill 3/16 in. x 1 in. pilot holes at the jaw screw locations, and then install VG CSK screws to secure the clamping jaw. Remove the threaded rod(s) and retain them for Step 5.4.



Secondary Member
Bottom Housing
Example

Clamping Jaw Screws, Primary Member

5.4 Clamping Jaws - Connecting the MEGANT Plates

Slide the two connector plates together. While the beam is unloaded, insert the rods through the unthreaded clamping jaw and until they are flush with the surface of the jaw. At this point, the threaded rod will be 1-3/16 in. proud of the unthreaded jaw. Each threaded rod is equipped with a hexagonal recess at one end. The end without this recess must be inserted into the threaded clamping jaw, allowing the accessible end to be turned using a hex key. Install the washer and nut on each rod. Tighten the nut to the recommended installation torque of 29.5 lb.:ft.

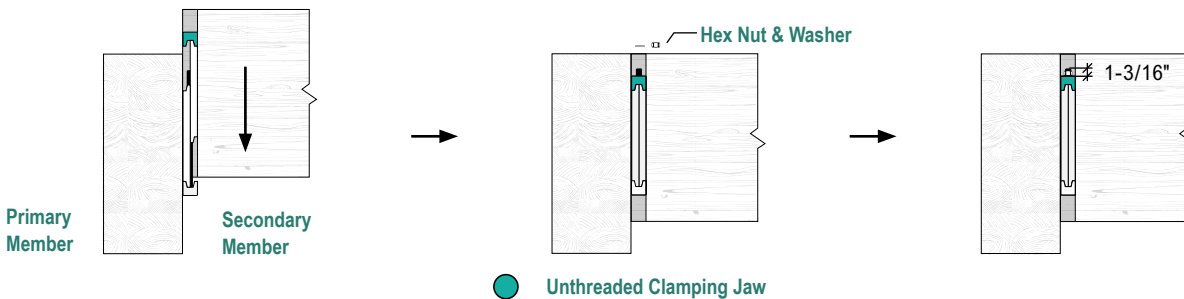

6.1 Optional Measures - Wood Plug

Where connectors are housed in the secondary beam, it is recommended to void in the routed void below the connector for aesthetics and fire protection. A wood plug may be used, and installation instructions shall be provided by the Engineer of Record.

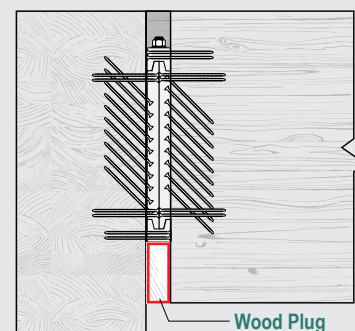



Bayview Elementary School

Vancouver, British Columbia

Accessories

Bits

Patented Bits for ASSY Fasteners

The ASSY RW is a hardened bit designed for quick and efficient installation of ASSY fasteners. Suitable bits for each fastener are listed in its specification table.



Snug Fit



Reduced Wobbling



Optimum Torque Transfer



RW 30

RW 40

RW 50

Bit Holder Socket

Bit Holder Socket for RW 50 Bits

The Bit Holder Socket is designed to hold RW 50 Bits on large double handle drills. The socket can be used with the magnetic bit holder case to facilitate the installation of larger-diameter screws which requires higher torque.

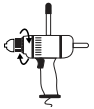

Suitable for Large Drills



RW 50 Compatible



Optimum Torque Transfer



Predrilling Jig

Eases Predrilling for Inclined Fasteners

Our Predrilling Jig is a versatile installation accessory designed to support more consistent and precise fastener installation with less effort and in less time than conventional predrilling processes. Available in three sizes to accommodate 5/16 in., 3/8 in., and 1/2 in. VG CSK fasteners, it is compatible with the inclined fasteners of the MEGANT and RICON S VS XL as well as custom steel-to-wood connections (with 45° Wedge Washers, 90° Cup Washers, or appropriately machined holes in steel plates of various thicknesses). The inner diameters, d , accommodate standard imperial and metric drill bit diameters recommended for predrilling (3/16 in., 1/4 in., and 17/64 in. respectively). The outer diameters, D , and shoulder geometries mirror the head of the fastener for rapid positioning and alignment, while a tight tolerance at the tip ensures a snug fit with minimal play in the receiving hole.

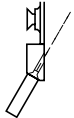

RICON S VS XL
Compatible

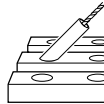

MEGANT
Compatible

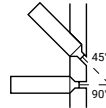

Compatible with
Multiple Angles

Recommended Diameters of Predrilled and Pilot Holes

Nominal Fastener Diameter [D]	Predrilled Hole Diameter	Pilot Hole Diameter	Steel Plate Hole Diameter
in.			
1/4	5/32	$\leq 5/32$	9/32
5/16	3/16	$\leq 3/16$	3/8
3/8	1/4	$\leq 1/4$	7/16
1/2	17/64	$\leq 17/64$	17/32
9/16	5/16	$\leq 5/16$	N/A

Notes:

- The predrilling length should be equivalent to the length of the fastener.
- Pilot holes are intended to facilitate the installation of the fasteners by reducing splitting risks, ensuring a proper penetration path and faster thread engagement with the wood fiber. A minimum pilot hole depth is 1 in. is recommended to obtain the aforementioned benefits.
- Predrilled holes that exceed the diameters listed above may reduce the capacity of the screws.
- These recommendations are applicable to ASSY fasteners supplied by MTC Solutions.
- Connection design must meet all the relevant requirements outlined in the Notes to the Designer section.

Clip Lock Brace System for Uplift

Clip Lock brace systems are additional components available for the RICON S VS beam hanger system. The Clip Lock is a special thin steel plate designed to fit into and lock the RICON S VS beam hanger plates together, yielding a resistance to uplift forces. The Clip Lock is installed with the hanger on the primary beam or column, and as the secondary beam is lowered into place, providing resistance to uplift loads. These components are installed using the same screws used to fasten the beam hanger plates into the wood member. A new screw pattern applies to the primary member to allow the Clip Lock to be installed properly, which results in a reduced download capacity.

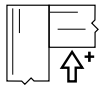
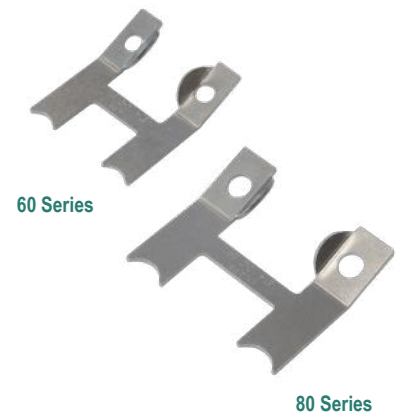

Uplift Force
Resistance

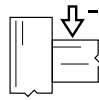

Reduced
Downward Force

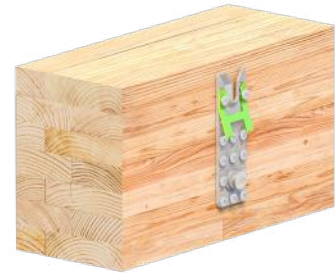

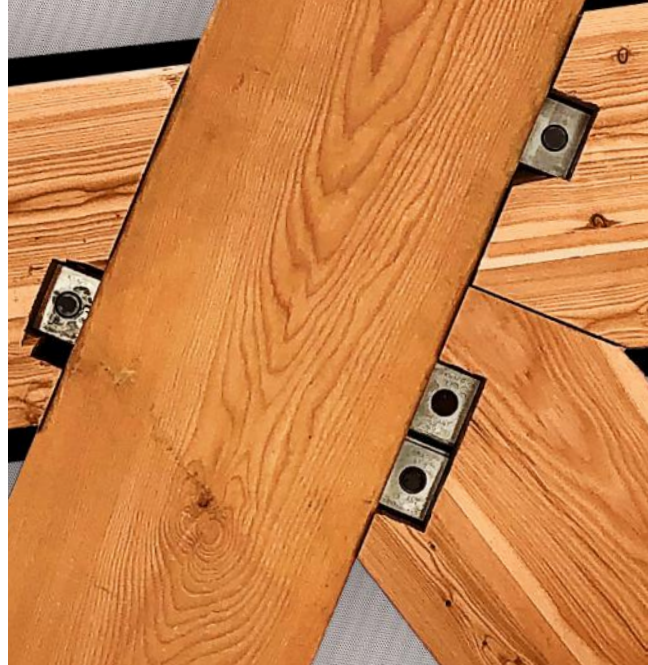

Clayton Community Centre

Surrey, British Columbia

Appendix

- APPENDIX A: FIRE PROTECTION..... 92**
 - Building Types and Associated Fire Protection 92
 - Balancing Connector Fire Protection and Member Sizing..... 92
 - Proposed Member Sizing Design Flow..... 93
 - Fire Protection for Connections..... 93
 - Standard Detailing Guidelines for MTC Products 96

- APPENDIX B: UPLIFT RESISTANCE DESIGN 98**
 - Example of Toe Screw Installation 98
 - Design Information for Toe Screw Connections..... 99

- APPENDIX C: SURVEY OF LITERATURE ON REINFORCEMENT FOR TENSION PERPENDICULAR TO GRAIN 100**
 - Strength of Members for Brittle Failure in Tension Perpendicular to Grain 100
 - Best Practices for Designing Reinforcement 104
 - Detailing Reinforcing Screws..... 107
 - Summary of Recommendations 108
 - References..... 108

- APPENDIX D: PRODUCT SPECIFICATIONS..... 109**

Appendix A: Fire Protection

Building Types and Associated Fire Protection

The International Building Code (IBC) 2024 contains three types of tall mass timber building, IV-A, IV-B, and IV-C. Key defining features of the building types include the allowable height, building area, and fire-resistance rating (FRR) requirements. As buildings increase in size and height, FRR requirements become more stringent. A Type IV-A building must meet a 3-hr FRR (IBC 2024 Table 601), and at least two thirds of that FRR must be achieved using noncombustible protection (IBC 2024 Section 602.4.1.2.1) such as Type X gypsum wallboard. Types IV-B and IV-C require the primary structural frame to meet a 2-hr FRR (IBC 2024 Table 601). Type IV-B structures have some requirements for noncombustible protection (IBC 2024 Section 602.4.2.2), whereas Type IV-C structures allow mass timber elements to be fully exposed (IBC 2024 Section 602.4.3.2). In short, the current building code requirements may require up to 2-hr FRR members and connections for exposed mass timber structural elements.

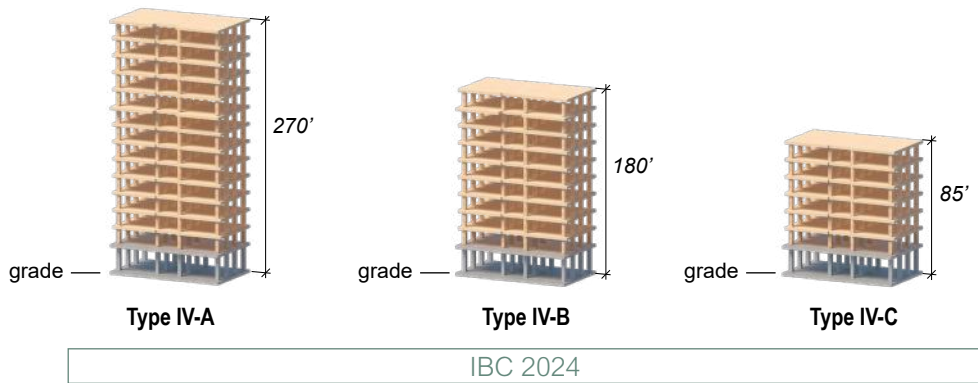

Figure A.1 - IBC 2024 Types of Mass Timber Buildings

IBC 2024 Section 722.1 allows designers to calculate FRR using NDS 2024 Chapter 16, which identifies wood as a combustible material and a poor conductor of heat. Wood develops an insulating char layer during a fire, and as such, can protect noncombustible elements such as beam hanger systems. The American Wood Council (AWC) Fire Design Standard (FDS) 2024 offers provisions for the design of fire-resistance-rated timber elements and their structural connections for durations of up to two hours.

Balancing Connector Fire Protection and Member Sizing

One challenge in fire protection design is ensuring connectors have sufficient wood cover in addition to the required fire resistance of the timber members. Designers commonly select member sizes before selecting the connectors, which can lead to conflicts when accommodating beam hangers. Both NDS 2024 and FDS 2024 require a minimum wood cover around the perimeter of a connector for fire resistance. While this is crucial for achieving the desired FRR, it can limit the available space for placing a beam hanger. Prioritizing the selection of a beam hanger system with the appropriate capacity before sizing the timber members ensures that the structural capacity of the member, the fire resistance of the member, and the fire protection of the connector are all achieved.

Proposed Member Sizing Design Flow

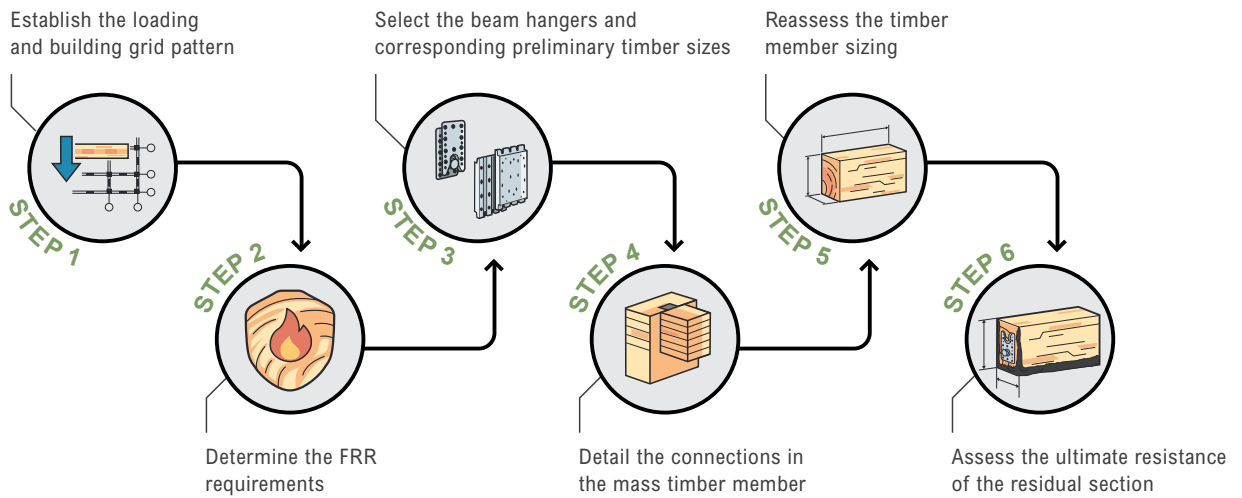

Figure A.2 - Proposed Member Sizing Design Flow

Fire Protection for Connections

IBC 2024 includes many options to demonstrate FRR, two of which are commonly used in mass timber connections: the calculation method outlined in NDS 2024 Chapter 16 and a testing method. The testing method has two options for compliance: a temperature pathway and a loading pathway.

Table A.1 - Methods to Demonstrate Fire Protection of Connections

Calculation Method	Testing Method	
	Temperature Pathway	Loading Pathway
<ul style="list-style-type: none"> Calculation in accordance with NDS 2024 Additional details found in FDS 2024 	<ul style="list-style-type: none"> Temperature-based acceptance criteria Approvals based on UL 2079 or ASTM E1966 Joint Testing Criteria Temperature curve following the trend specified in ASTM E119 	<ul style="list-style-type: none"> Full-scale, fully loaded testing Must follow prescribed test configuration details (e.g., height of column above the connector that may prevent plug shear failure) Acceptance criteria includes maintaining load for the entirety of the test Temperature curve following the trend specified in ASTM E119

Calculations for Connections without Approved Fire-Resistant Joint Systems

NDS 2024 Chapter 16 refers to FDS 2024 for the design of wood cover around metallic parts of a connection. FDS 2024 Section 3.10 requires all components of a connection to be protected. This includes metal connectors, fasteners that are part of the structural connection, and portions of the members that are part of the structural connection.

The depth of char penetration into the wood members, a_{char} , is calculated using FDS 2024 Eqs. 3.2-1 and 3.2-2. It is allowed to assume a nominal char rate, β_n , of 1.5 in./hr for sawn lumber, glulam, LVL, and CLT products. The char penetration at intersecting members is dependent on if there is an approved fire-resistant joint in accordance with FDS 2024 Section 2.5.1.3.

FDS 2024 Section 3.2.3 stipulates that for connections without an approved fire-resistant joint, char contraction must be considered at the ends of exposed wood members, with a penetration depth of $2 \cdot a_{char}$ (Figure A.3a). This approach requires the gap between the two members to be less than or equal to 1/8 in., and that airflow through the gap must be prevented. If the gap between members is greater than 1/8 in., or if the gap is less than or equal to 1/8 in. and airflow cannot be prevented, then both members must be treated as fully exposed (Figure A.3b), which is considered incompatible with pre-engineered beam hanger connection designs.

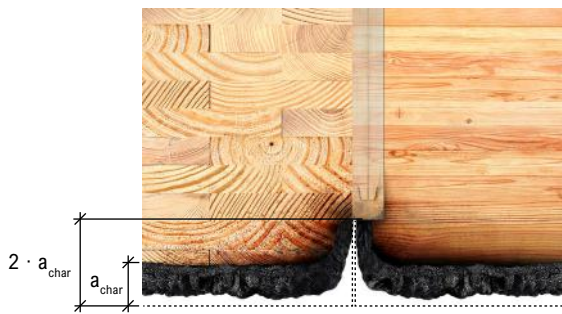

Figure A.3a - Char Contraction for Members $\leq 1/8$ in. Apart



Figure A.3b - Char Contraction for Exposed Members

NDS 2024 Table 16.3.1 gives values for a_{char} for various FRR. The minimum cover shown in Table A.2 below assumes no fire-resistant joint is present at the intersection of the wood members.

Table A.2 - Char Depth and Required Wood Cover for Intersecting Members Without No Fire-Resistant Joint

FRR	Char Depth, a_{char}	Wood Cover Depth, d_p
hr	in.	
1	1.5	3.0
2	2.6	5.2

Calculations for Connections with Approved Fire-Resistant Joint Systems

FDS 2024 Section 3.2.3.1 allows members with an approved fire-resistant joint system (in accordance with Section 2.5.1.3) to use a char penetration between wood members equal to a_{char} as opposed to $2 \cdot a_{char}$ required when considering char contraction. Common materials used in fire-resistant joints include mineral wool insulation, intumescent tape, and fire sealants.

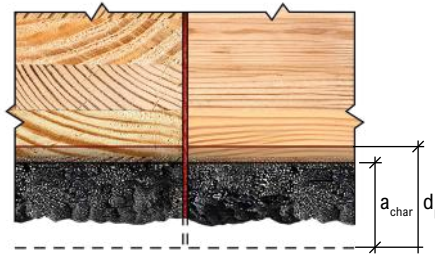

Figure A.4 - Char Penetration with an Approved Fire-Resistant Joint

Maximum Gap Size: The maximum allowable gap depends on the specific fire protection method used.

Adjustment Factor for Wood Cover: FDS 2024 Section 3.6.1.1 states that when a single layer of wood cover is used for thermal separation, its calculated protection time must be reduced by 15%.

Combining FDS 2024 Eqs. 3.2-2 and 3.4-2 with the provisions from FDS 3.2.1.1 gives the depth of the wood cover, d_p , in inches.

$$d_p = 1.14a_{char} \quad \text{(eq. A.1)}$$

Using this approach, the required wood cover for protected joints is shown in Table A.3 below.

Table A.3 - Char Depth and Required Wood Cover for Intersecting Members With an Approved Fire-Resistant Joint

FRR	Char Depth, a_{char}	Wood Cover Depth, d_p
hr	in.	
1	1.5	1.7
2	2.6	3

Corner Rounding Effect: The intersecting char fronts for members exposed on more than one side causes increased charring at the corners. The radius of the corner rounding, r , can be taken as a_{char} . If the metallic parts are installed too low in the beam section, they may be exposed to excessive heat early due to corner rounding char as shown in Figure A.4.

This leads to two possible scenarios:

1. The beam will need to be wider to prevent the rounded corners affecting the metallic parts.
2. The metallic parts will be pushed higher in the beam section.



Figure A.5 - Corner Rounding Effects

Standard Detailing Guidelines for MTC Products

Unless indicated otherwise, the tabulated FRR beam sizes presented in the design tables in this guide are calculated assuming the use of an approved fire-resistant joint. The most common solutions for FRR compliance involve the use of fire caulking and intumescent tape. These products should be applied in accordance with the manufacturer's specifications.

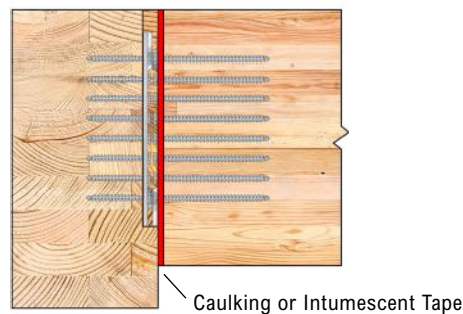

Figure A.6 - Fire-Resistant Joint

Void Below Connectors: Some connector models, such as the RICON S VS XL and the MEGANT series, require a void below them to facilitate proper installation. Unless otherwise indicated, the void must be filled with appropriate fire-stopping materials such as mineral wool insulation, intumescent tape, fire sealants, or a wood plug.

Wood Plug: In some installation configurations, the housing extends the full depth of the secondary member, leaving a void at the bottom. Thus, a wood plug is necessary to ensure the required FRR during the service life of the connection. FDS 2024 Section 3.4.1.4 stipulates that fasteners used to attach wood protection do not need to be protected; however, the fasteners must be long enough to penetrate the protected member by at least 1 in.

Additional Fire Design Considerations for MEGANT Connectors: The threaded rod assembly must be taken into account when determining the placement of the connector in the beam section and evaluating its FRR. The threaded rods extend 1-3/16 in. above the edge of the clamping jaw in all MEGANT connectors.

Appendix B: Uplift Resistance Design

Additional hardware is required to resist uplift forces with beam hanger systems. This can be achieved by installing fully threaded toe screws after the connectors are in place. The orientation of each screw relative to the joint assures that the screw primarily resists uplift through tension. Fully threaded screws are compatible with all beam hanger systems.

For RICON S VS hangers, uplift resistance can also be achieved using a Clip Lock system. More details on this option are presented in the RICON S VS chapter.

To ensure proper performance, installation of the beam hanger system and toe screw is essential. Minimum spacing requirements must be satisfied to prevent interference between fasteners and ensure the integrity and performance of the connection.

Example of Toe Screw Installation

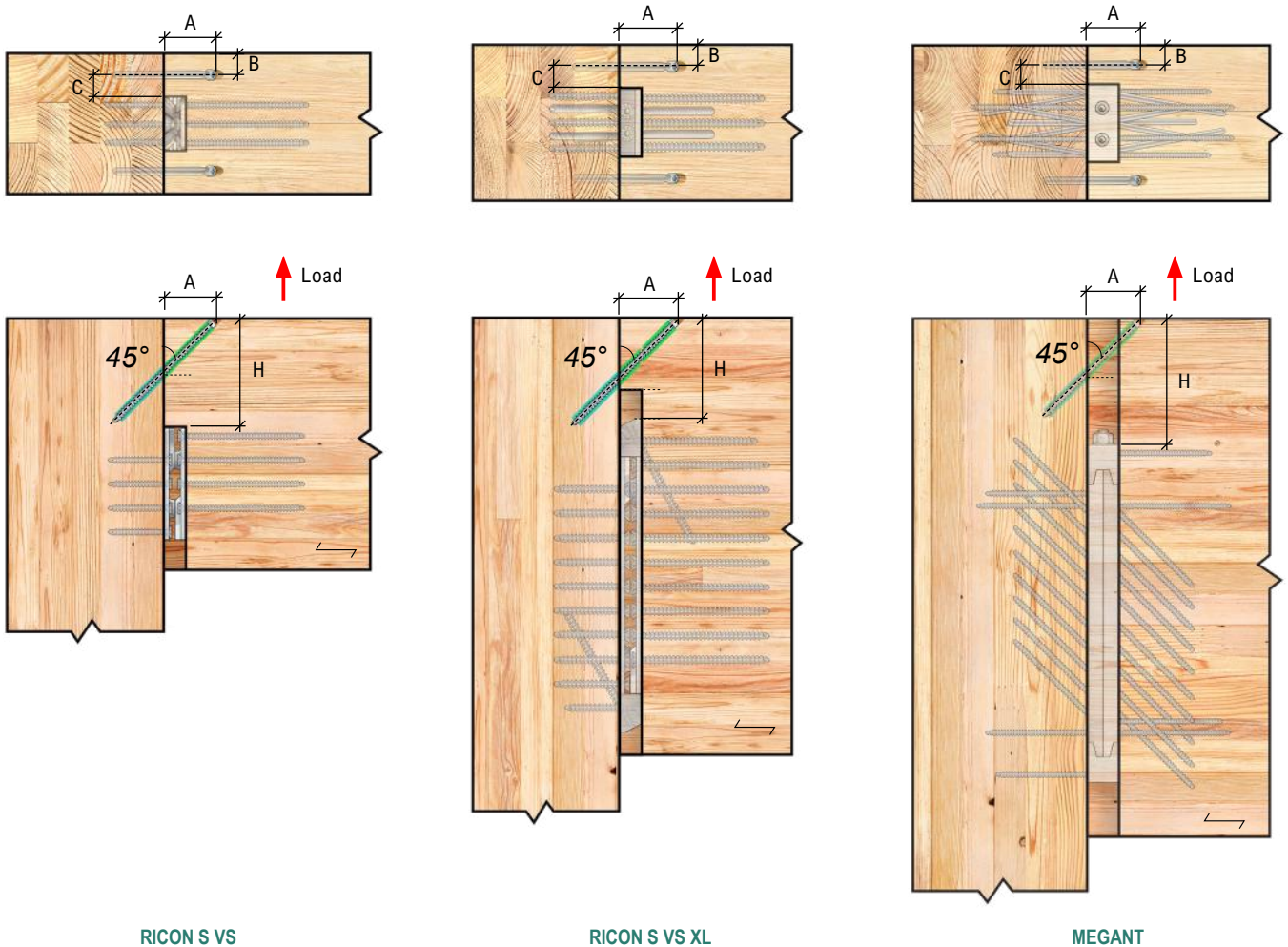

Design Information for Toe Screw Connections

Table B.1. - Geometry Requirements

Toe Screw Diameter	Minimum Screw Length	Minimum Insertion Point End Distance	Minimum Distance to Edge of Beam	Minimum Distance to Edge of Hanger
D	L	A	B	C
in.				
—	20D	8D	3D	3D
5/16	6-1/4	2-1/2	15/16	15/16
3/8	7-7/8	3	1-1/8	1-1/8

Notes:

- All connection design must meet all the relevant requirements of the Notes to the Designer section.
- Geometry requirements are in accordance with ICC-ESR-3178 (2024).
- In wood species sensitive to splitting, minimum geometry requirements may be required to be increased.
- If the insertion point end distance is greater than the distance from the top of the beam to the top of the hanger minus four times the diameter of the screw (i.e., $A > H - 4D$), then each inclined screw should be located at least a distance of C from the hanger.

Table B.2. - Allowable Adjusted Uplift Design Values for Single Toe Screws

Fasteners		Insertion Point End Distance [in.]	Allowable Uplift [lb.]		Cost
Type	Qty.		A	G = 0.42	
VG CYL	5/16" x 6-1/4"	2	2-1/2	1,130	1,320
	5/16" x 7-7/8"		3	1,530	1,790
	5/16" x 8-5/8"		3-1/4	1,680	1,970
	5/16" x 9-1/2"		3-1/2	1,840	2,150
	5/16" x 10-1/4"		4	1,950	2,280
	5/16" x 11"		4	2,140	2,510
	5/16" x 11-7/8"		4-1/2	2,350	N/A
	5/16" x 13"		4-3/4	2,510	N/A
VG CYL	3/8" x 11-7/8"	2	4-1/2	2,630	3,100
	3/8" x 12-5/8"		4-3/4	2,800	3,310
	3/8" x 13-3/8"		5	2,980	3,520
	3/8" x 14-1/4"		5-1/4	3,150	3,610
	3/8" x 15"		5-1/2	3,320	N/A
	3/8" x 15-3/4"		5-3/4	3,490	N/A
	3/8" x 17"		6-1/4	3,610	N/A

Notes:

- Tabulated allowable uplift loads are based on a short-term load duration, C_D , of 1.6.
- Tabulated allowable uplift loads are for two fasteners installed at 45° in a beam-to-column configuration as shown on the previous page.
- Tabulated allowable uplift loads assume the fasteners are not installed in a void between lamelas of split-laminated glulam members.
- Tabulated allowable uplift loads are based on both glulam members (i.e., column and beam) having the same specific gravity. Where specific gravities between the primary and secondary members differ, the lower value shall be used.
- Tabulated allowable uplift loads are only valid for Allowable Stress Design (ASD).
- Highlighted allowable uplift cells indicate a value where the tensile strength of the fastener governs the design. No further increase in strength can be achieved with longer screws.
- Tabulated values are based on at least two fasteners per connection.

Appendix C: Survey of Literature on Reinforcement for Tension Perpendicular to Grain

Connecting beams by side-loading or end-support in mass timber structures requires careful placement of fasteners and the consideration of perpendicular-to-grain tensile stresses. If required, reinforcing screws can be used to prevent wood splitting by providing a load path for tension perpendicular to grain. This appendix provides a **literature review** of best practices, focusing on advanced techniques like self-tapping screws, based on the latest research and applications. It is crucial that all engineering work be completed by a licensed Professional Engineer of Record (EOR) to ensure safety and compliance with the appropriate codes and standards.

Strength of Members for Brittle Failure in Tension Perpendicular to Grain

This appendix focuses exclusively on perpendicular-to-grain brittle failure modes in wood connections, emphasizing the importance of careful design. EORs should be particularly attentive to tension-induced splitting at points of load application and beam-end fracture at points of support. NDS 2024 offers limited-and sometimes overly conservative guidelines for these failure modes. Through this literature review, we aim to provide EORs with comprehensive background knowledge, enabling them to make informed, consistent decisions that align with best practices across various design standards.

Splitting Resistance of Wood Members in Connections Loaded Perpendicular to Grain

Perpendicular-to-grain tension-induced splitting can occur if loads are applied without engaging enough of the member's depth, such as in a connection placed low on a member's side (see Figure C.1). In these scenarios, reinforcement may be required based on fastener height and load magnitude.

Splitting is a concern when a connection applies load to a member, unless the connection includes fasteners that engage at least 70% of the beam's depth from the loaded edge, as indicated by CSA O86:24 and Eurocode 5 EN 1995-1-1:2004.

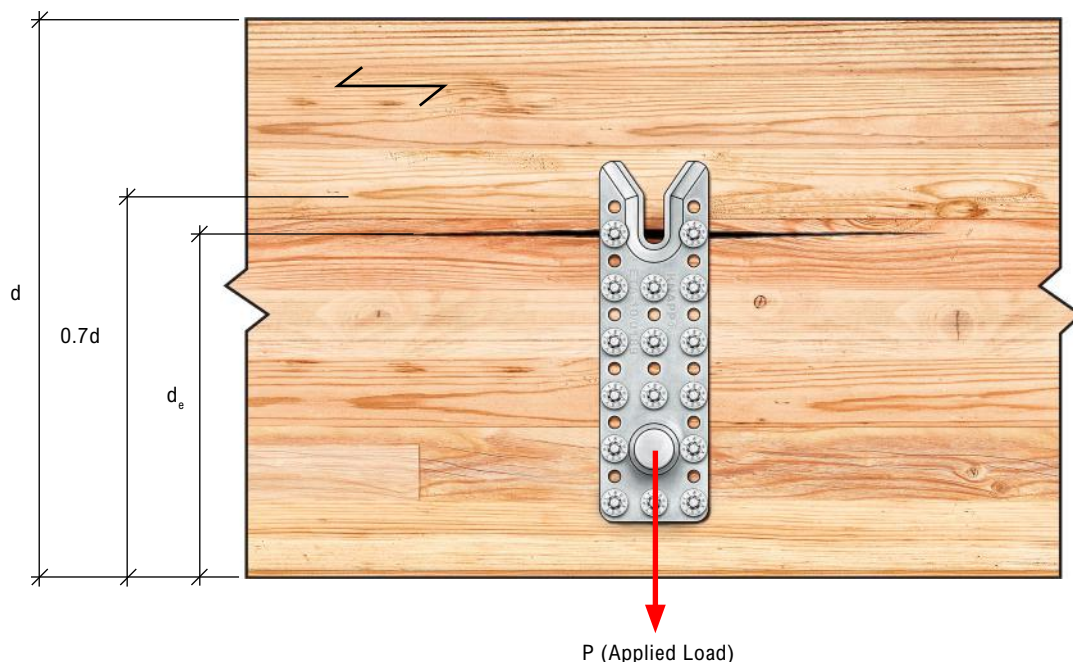

Figure C.1 - Splitting at Low Connection on Primary Member's Side

NDS 2024 does not provide criteria to evaluate the splitting strength of members for connections that are side-loaded perpendicular to grain. For this condition, the EOR should refer to NDS 2024 Section 1.1.1.5, which states that they may use design procedures not explicitly given in the Standard, provided that these methods are based on a recognized theory that gives satisfactory results. Therefore, the theory must provide a reference design value that aligns with NDS 2024 principles, including a 10-year load duration, dry service conditions, temperatures below 100°F, and an appropriate factor of safety. Some international standards provide methods for estimating splitting resistance. For example, CSA O86:24 Clause 12.12.10.8 presents an equation for the factored splitting resistance, QS_{rT} , of an untreated wood member in dry service conditions when fasteners engage less than 70% of the member's depth.

$$QS_{rT} = \phi_w \cdot K_D \cdot C_{5\%} \cdot l_s \cdot \sqrt{\frac{d_e}{1 - \frac{d_e}{d}}} \quad (\text{eq. C.1})$$

Where:

QS_{rT}	factored splitting resistance of an untreated wood member in a connection loaded perpendicular to grain in dry service conditions in N
ϕ_w	resistance factor for brittle failures, taken as 0.7
K_D	load duration factor from CSA O86:24, set at unity for standard-duration transient loads such as snow and occupancy
$C_{5\%}$	constant for the fifth percentile splitting capacity of softwood lumber in CSA O86:24, taken as 14 N/mm ^{1.5}
l_s	bearing length of the screws for partially penetrated members in mm, denoted as t_f in CSA O86:24
d_e	effective shear depth in mm
d	depth of the member in mm

To obtain reference design values aligned with NDS principles, one possible approach is to adjust the equation presented above using a suitable load duration, a factor of safety aligned with NDS 2024, and conversion factors to accommodate imperial units. The equation below is provided as a potential method for estimating NDS 2024 reference design values for splitting in softwood lumber connections loaded perpendicular to grain when fasteners engage less than 70% of the member's depth.

$$F_{pt} = \frac{C_{5\%} \cdot C_{lb} \cdot C_{D,CSA} \cdot l_s \cdot C_{in}}{C_D \cdot C_{des}} \cdot \sqrt{\frac{d_e \cdot C_{in}}{1 - \frac{d_e}{d}}} \quad (\text{eq. C.2})$$

Where:

F_{pt}	estimated reference design value for splitting strength of a wood member in a of a connection loaded perpendicular to grain in lb.
$C_{5\%}$	constant for fifth percentile splitting capacity of softwood lumber in CSA O86:24, taken as 14 N/mm ^{1.5}
C_{lb}	conversion factor for force units, taken as 0.2248 to convert N to lb.
$C_{D,CSA}$	conversion factor for load duration, taken as 1.25 to convert from CSA O86:24 standard-term duration to NDS 2024 10-min. load duration
l_s	bearing length of the screws for partially penetrated members in in.
C_{in}	conversion factor for length units, taken as 25.4 to convert mm to in.
C_D	load duration factor from NDS 2024, taken as 1.6 for short-term loading and used here to convert from NDS 2024 10-min. load duration to reference 10-yr load duration
C_{des}	conversion factor for design method, taken as 2.0 to convert from CSA Limit States Design to NDS Allowable Stress Design
d_e	effective shear depth, taken as the distance from the loaded edge of the member to the furthest fastener row, in in.
d	depth of the member in in.

It is the EOR's responsibility to satisfy themselves that any formulas they use for design are appropriate for their specific situation. If the EOR deems the equation given above is appropriate for use, its simplified version can be applied as follows:

$$F_{pt} = 157 \cdot l_s \cdot \sqrt{\frac{d_e}{1 - \frac{d_e}{d}}} \quad \text{(eq. C.3)}$$

The reference design value obtained using the above equation shall be multiplied by the applicable adjustment factors in NDS 2024 to determine the adjusted design value for splitting resistance for a connection loaded perpendicular to grain, F'_{pt} . For ASD, the applicable adjustment factors are C_D (NDS 2024 Table 2.3.2), C_M (NDS 2024 Table 11.3.3), and C_t (NDS 2024 Table 11.3.4). In addition, the member shall be of sufficient size to carry the applied load without exceeding the adjusted design value; otherwise, the member shall be reinforced.

Beam-End Fracture Strength of Members at Points of Support

Beam-end fracture in members can be induced by excessive cross-grain tension. Connections that provide support to beams may require reinforcement to prevent beam-end fracture if they do not support the bottom of the members, such as illustrated in the following examples.

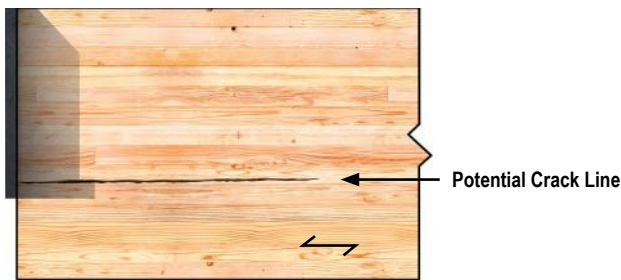

Figure C.2 - Concealed Bearing Plate Does Not Support Bottom of Member



Figure C.3 - Lowest Dowel in Knife Plate Connection Does Not Support Bottom of Member

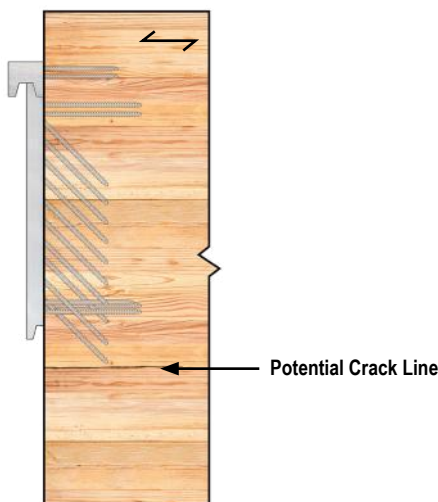

Figure C.4 - Lowest Inclined Fastener in Beam Hanger Does Not Support Bottom of Member

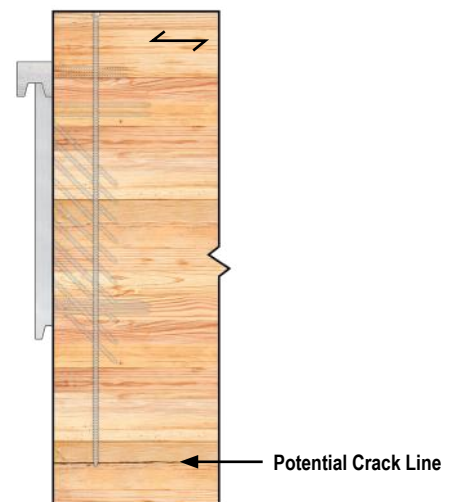

Figure C.5 - Effective Threads of Reinforcing Screw Does Not Extend to Bottom of Member

Because beam-end splitting depends on support conditions and load levels, the EOR must ensure that end splitting does not occur. Research indicates that beams are safe from end splitting when supported by MTC hangers at their allowable design loads when positioned according to Table C.1.

Table C.1 - Relative Connector Positioning at Beam-End Locations

Product	Minimum Distance from Lowest Fastener to Loaded Edge in Secondary Member
GIGANT	0.7d
RICON S VS	0.8d
MEGANT	0.7d

For cases not covered by Table C.1, NDS 2024 Eq. 3.4-6 (Eq. C.4 below) provides a method for calculating the design shear strength, V'_r , near the end of a beam where part of its depth is unsupported by the connection (see Figure C.6). The adjusted design shear strength is reduced to reflect both the loss of load transfer capability due to increased tensile stress perpendicular to grain, although research has shown that this calculation method is very conservative. This equation applies to any connection within five times the member depth from the beam-end. To prevent this reduced shear strength, either engage more of the beam's depth with the connection, or reinforce the member at the connection location.

$$V'_r = \left(\frac{2}{3} \cdot F'_v \cdot b \cdot d_e \right) \left(\frac{d_e}{d} \right)^2 \quad \text{(eq. C.4)} \\ \text{(NDS 2024 eq. 3.4-6)}$$

Where:

F'_v adjusted shear strength of the member in psi

According to NDS 2024 Eq. 3.4-7 (Eq. C.5 below), when a connection provides support to a member and is located at least 5d from its end, the adjusted design shear, V'_r , is permitted to be calculated as:

$$V'_r = \frac{2}{3} \cdot F'_v \cdot b \cdot d_e \quad \text{(eq. C.5)} \\ \text{(NDS 2024 eq. 3.4-7)}$$

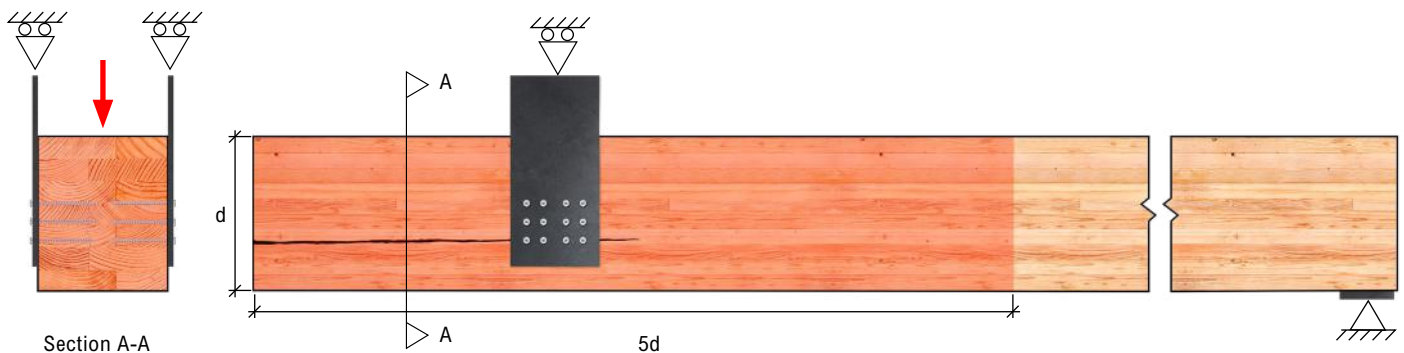

Figure C.6 - Splitting of Beam Supported Near its End

Best Practices for Designing Reinforcement

Reinforcement for Preventing Splitting at Points of Load Application

Existing literature indicates that when a secondary member connects too low on the side of a primary member and engages less than 70% of its depth, it is necessary to calculate the adjusted design value for splitting perpendicular to grain, F'_{pt} . Should the applied load, P , exceed this value, reinforcing the member with self-tapping screws often proves more economical than increasing the member's size. This approach is especially critical for connections where prioritizing placement in the primary member can significantly minimize the forces associated with beam-end splitting perpendicular to the grain in the secondary member

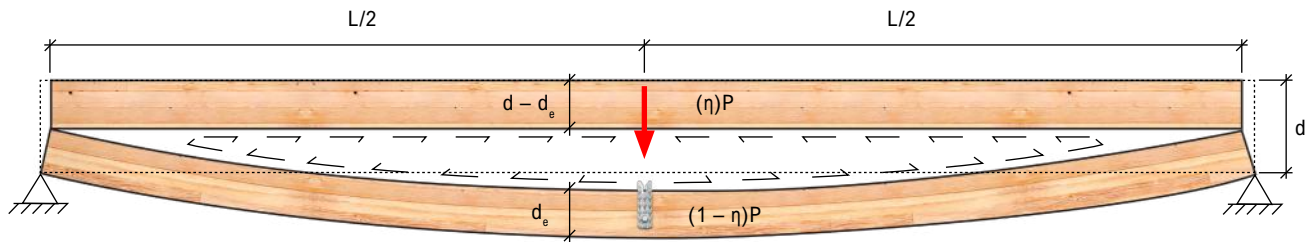

Figure C.7 - Beam Splitting with Hanger Installed at Mid-Span

Figure C.7 illustrates a split beam due to a load applied by a hanger installed at mid-span, where the top fasteners are located at a distance of d_e from the bottom edge. In this scenario, the lower beam section, with a depth of d_e , supports the entire load, P . If reinforcing screws connect the upper and lower beam sections at mid-span, they will distribute a portion of the load, ηP , to the upper section and its remaining portion, $(1 - \eta)P$, to the lower section. The formula below ensures deflection compatibility between the upper and lower portions of the split beam and is applicable to various loading configurations, not just at mid-span.

$$P_R = \eta \cdot P \quad (\text{eq. C.6})$$

Where:

$$\eta = 1 - 3 \left(\frac{d_e}{d} \right)^2 + 2 \left(\frac{d_e}{d} \right)^3 \quad (\text{eq. C.7})$$

With the design load for the reinforcing screws, P_R , now able to be calculated, all information needed to design the reinforcing screws is available. Typical practice would be to provide a fully threaded self-tapping screw on each side of the hanger. Fasteners should be spaced $1.5D$ from the nearest beam hanger and $3D$ from the front edge of the primary beam, where D is the nominal diameter of the fastener. In such a case, each screw would be designed to support half of the calculated design load (i.e., $P_R / 2$) given by the formula above.

Fully threaded reinforcing screws supplied by MTC should be designed following the requirements of ICC-ESR 3178 (2024). As outlined above, the location of the top row of fasteners in the hanger defines the location where splitting would occur in the member. The split can be considered to create an upper member and a lower member at its location. The upper member at this location equates to the “side” member noted in ICC-ESR 3178 (2024) that defines its thickness, $t_{s,w}$, as follows:

$$t_{s,w} = d - d_e \quad (\text{eq. C.8})$$

Assuming the head of the screw is set flush with the top surface of the beam, the effective thread lengths above, $L_{eff,s}$, and below, $L_{eff,m}$, the location of the split can then be calculated as:

$$L_{eff,s} = t_{s,w} - L_{un} \tag{eq. C.9}$$

$$L_{eff,m} = L - t_{s,w} - L_{tip} \tag{eq. C.10}$$

Where:

- L_{un} length of the unthreaded portion of the screw, measured from screw head to the start of the threads
- L_{tip} length of the screw tip, equivalent to the nominal fastener diameter, D

In addition, in scenarios where the hanger will be subjected to uplift loads greater than the adjusted design value for splitting perpendicular to grain for this condition, to prevent splitting at the screw tip, embed it at least $0.7d$ below the top of the member, as shown in Figure C.8.

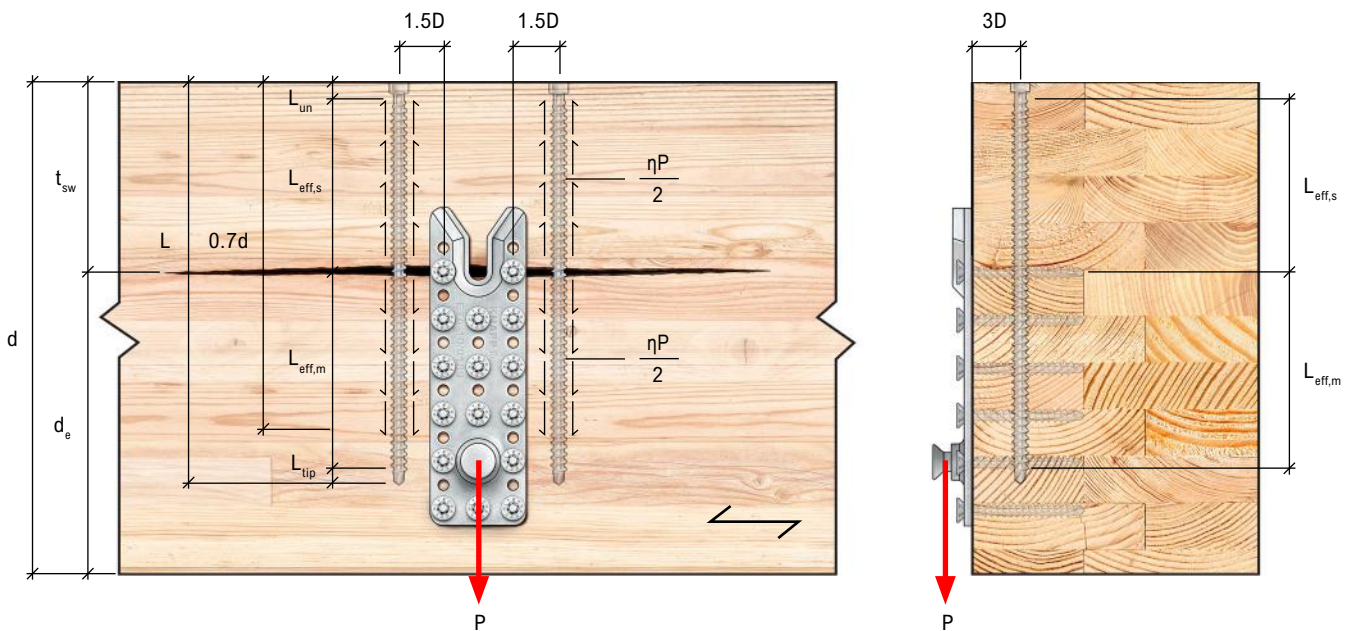

Figure C.8 - Force Distribution and Reinforcement Placement in Side of Member

Reinforcement for Preventing Beam-End Fracture at Points of Support

NDS 2024 does not offer specific guidance for designing reinforcement for members susceptible to beam-end fracture. For beams determined to have insufficient shear capacity at end supports, the EOR can reference Timber Engineering Principles for Design by H.J. Blaß and C. Sandhaas which offers the following equation for determining the load transferred by reinforcing screws, P_R , across the fracture plane at the end of a beam:

$$P_R = 1.3 \cdot \left[3 \left(1 - \frac{d_e}{d} \right)^2 - 2 \left(1 - \frac{d_e}{d} \right)^3 \right] \cdot V \quad (\text{eq. C.11})$$

Where:

V shear force in the member being transferred to the support in lb.

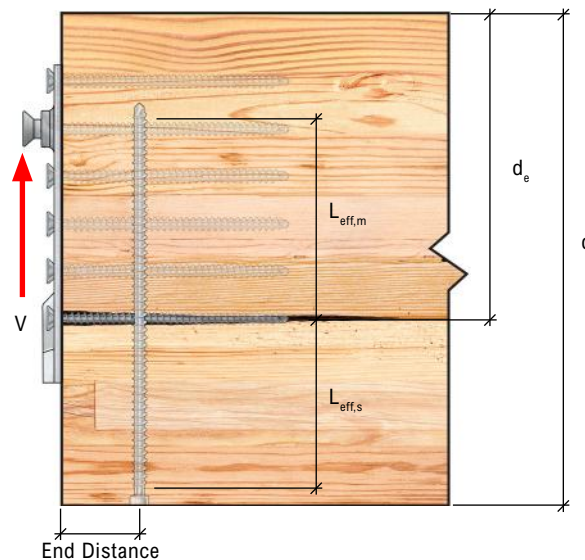

Figure C.9 - Reinforcement Placement in Beam-End

Only one row of reinforcing screws should be used to ensure even load distribution among all screws. Existing literature suggests that for typical gravity applications in beam-end connections, these fasteners should be installed from the bottom and penetrate as close to the top of the beam as possible. When designing reinforcement, it is best practice to position the row of reinforcing screws as close to the end of the beam as possible. The spacing, as well as end and edge distance, requirements for MTC fully threaded self-tapping screws can be found in the MTC Solutions Structural Screw Catalog.

Detailing Reinforcing Screws

C.1 Placement of Reinforcing Screws for Equal Load Sharing

To ensure equal load sharing among reinforcing screws:

- In the primary member, reinforcing screws should be oriented in a single row on each side of the hanger, with all screws positioned the same distance, s , from the centerline of the hanger.
- In the secondary member, reinforcing screws should be oriented in a single row, with all screws positioned the same distance, a , from the end of the secondary member.

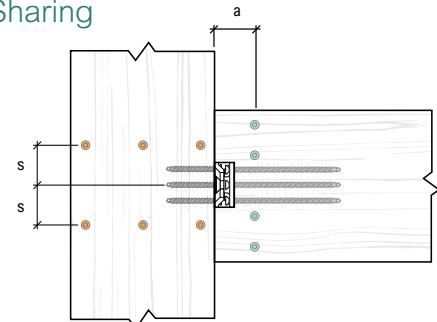

Figure C.10 - Reinforcing Screw Placement for Equal Load Sharing

C.2 Avoiding Screw Collisions

To avoid screw collisions, reinforcing screws should be installed beside the beam hanger rather than between its fasteners. If two beam hangers are placed side-by-side to support the end of a member, a reinforcing screw should be installed on each side of the dual-hanger assembly and ideally between the two hangers.

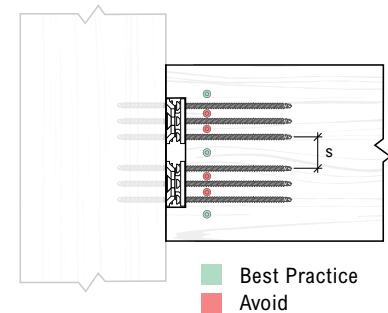

Figure C.11 - Reinforcing Screw Placement for Avoiding Screw Collisions

C.3 Installing Reinforcing Screws Near Edges

Screws installed near an edge of a member may be angled slightly inward (by approximately 5°) to mitigate the risk of deviating during installation and protruding from the side of the member.

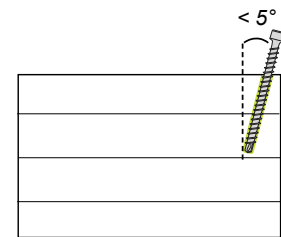

Figure C.12 - Reinforcing Screw Placement Near an Edge

C.4 Considering Tool Requirements Needed to Accommodate Installation

Typically, reinforcing screws should be installed before the member is placed in its final configuration. When this is not possible, the EOR must consider the space required for installation tools, the length of the reinforcing screws, and the installation sequence of adjacent components.

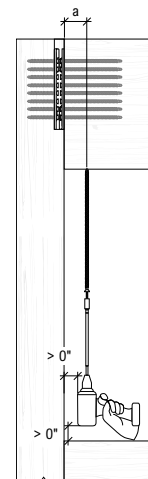

Figure C.13 - Accommodation of Tools During Installation

Summary of Recommendations

Recommendation	Reasoning
Only install a single row of reinforcing screws	Forces are not evenly distributed across multiple rows of fasteners
Prioritize placement of the secondary member to avoid reinforcement, helping isolate reinforcement only to the primary member	This results in more efficient design and more space for reinforcement in the primary member
Ensure screw spacing meets manufacturer's guidelines	This helps prevent screw collisions and wood splitting;
Reinforcing screws near beam edges may be angled slightly inward (by approximately 5°) if geometry can be accommodated	This minimizes the risk of screw deviation from the side of the beam during installation
Pilot holes should be drilled as close to the full length of the screws as possible.	This facilitates a proper penetration path for screws and reduces the risk of screw collisions

References

- Branco, J, Dietsch, P, and Tannert, T (eds.). (2021). *Reinforcement of Timber Elements in Existing Structures. State-of-the-Art Report of the RILEM TC 245-RTE*, Springer, ISBN 978-3-030-67794-7.
- Harte, A, and Dietsch, P (eds). (2015). *Reinforcement of Timber Structures: A State-of-the-Art Report*. Shaker, ISBN-10: 3844037519.
- European Committee for Standardization (CEN). (2023). *DRAFT prEN 1995-1-1 Eurocode 5 - Design of timber structures - Part 1-1: General rules and rules for buildings*, Brussels, Belgium.
- Green, M, Karsh, JE. (2012). *The Case for Tall Wood Buildings*, Vancouver, Canada. Wood Enterprise Coalition.
- Blaß, HJ, Bejtka, I. (2004). *Reinforcements perpendicular to the grain using self-tapping screws*, Lahti, Finland. *Proceedings of the World Conference of Timber Engineering WCTE*.
- Blaß, HJ, Sandhaas, C. (2017). *Timber Engineering Principles for Design*, KIT Scientific Publishing, ISBN 978-3-7315-0673-7.
- Deutsches Institut für Bautechnik (DIBt). (2018). *ETA-11/0190 Würth self-tapping screws*, Berlin, Germany.
- ETA-Danmark A/S. (2022). *ETA-10/0189 Knapp clip connectors and hold downs type Gigant, Ricon, and Walco*, Nordhavn, Denmark.
- Austrian Institute of Construction Engineering (OIB). (2019). *ETA-15/0667 Knapp Clip Connector type Megant*, Vienna, Austria.
- National Research Council of Canada (NRC). (2020). *Evaluation Report CCMC 13677-R SWG ASSY® VG Plus and SWG ASSY® 3.0 Self-Tapping Wood Screws*, Ottawa, Canada, ISSN 1206-1220.
- American Wood Council (AWC). (2024). *National Design Specification for Wood Construction with Commentary 2024 Edition*, Leesburg, USA, ISBN 978-1-940383-6.
- Canadian Standards Association (CSA). (2024). *CSA O86:24 Engineering design in wood*, Toronto, Canada, ISBN 978-1-4883-5082-5.

Appendix D: Product Specifications

This appendix provides more precise dimensions for the different beam hanger components referenced in this design guide. Detailed 2D and 3D geometry files are available for download on the respective product pages.

GIGANT

GIGANT 120 x 40

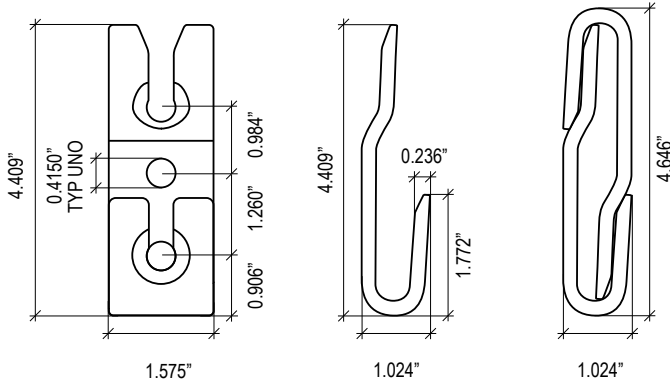

GIGANT 150 x 40

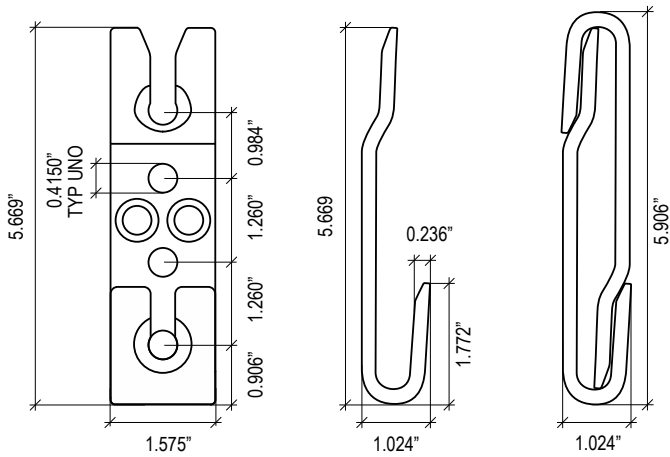

GIGANT 180 x 40

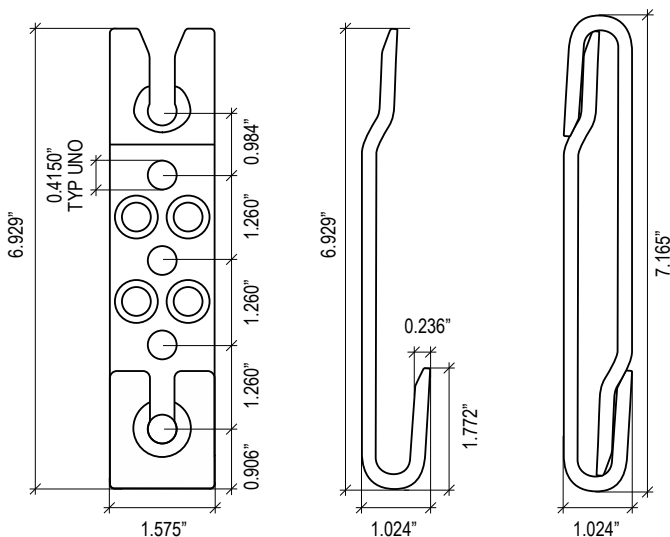

RICON S VS

RICON S VS 140 x 60

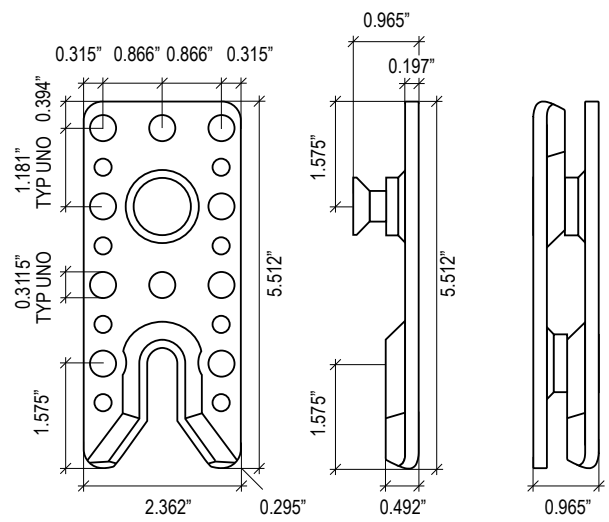

RICON S VS 200 x 60

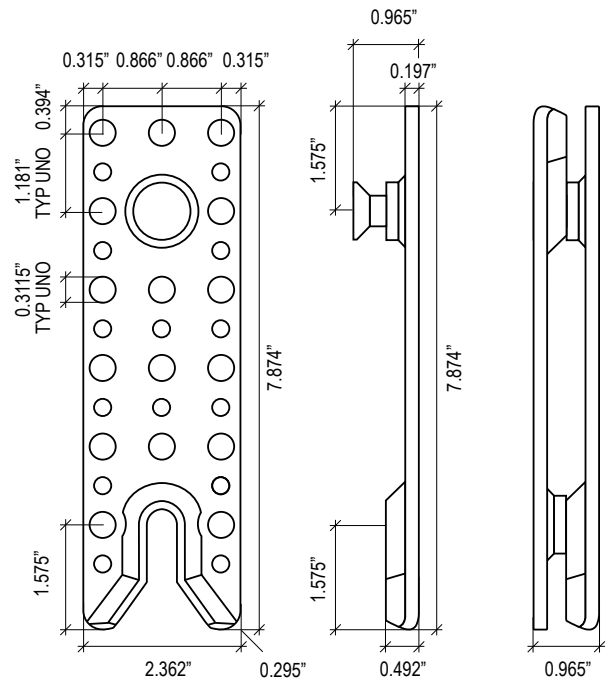

RICON S VS 200 x 80

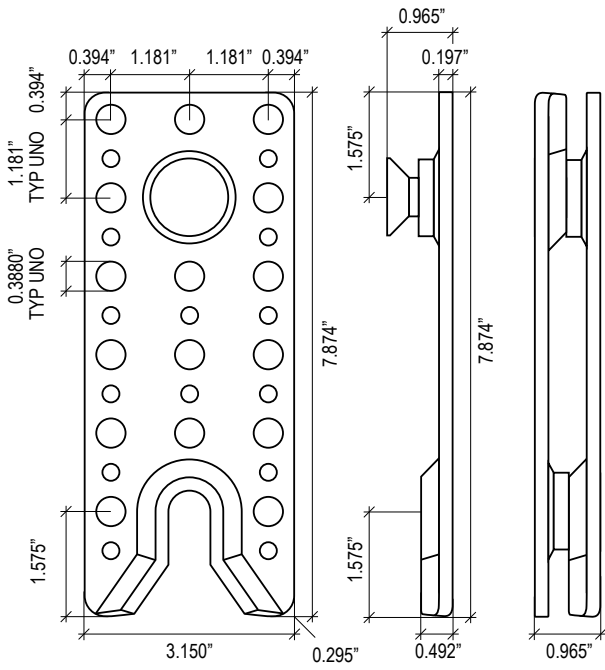

RICON S VS 290 x 80

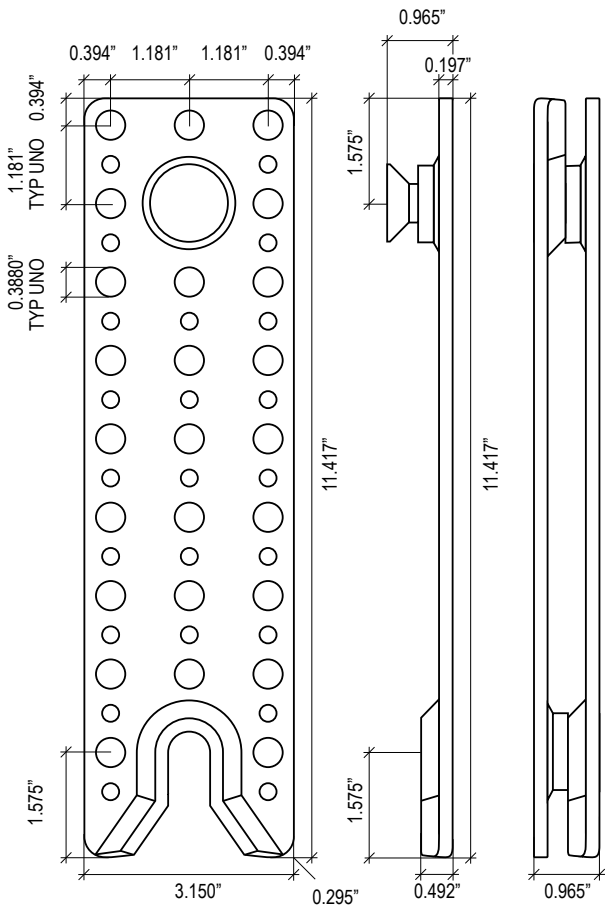

RICON S VS XL 390 x 80

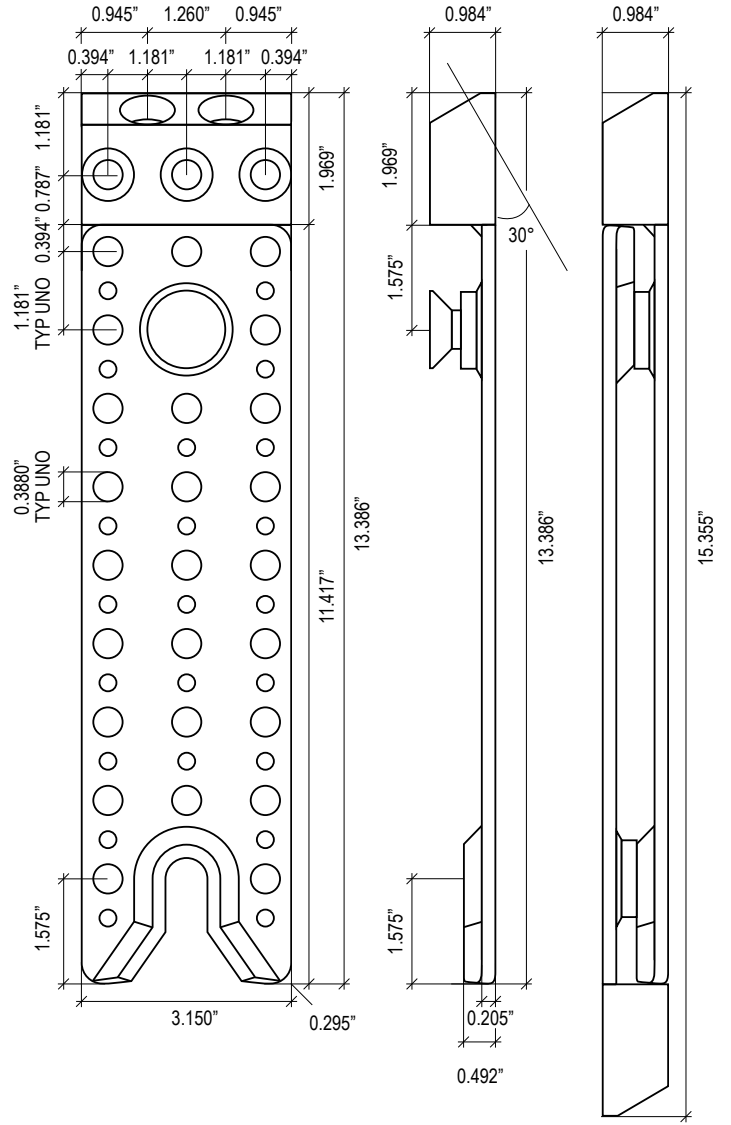

MEGANT 60 SERIES

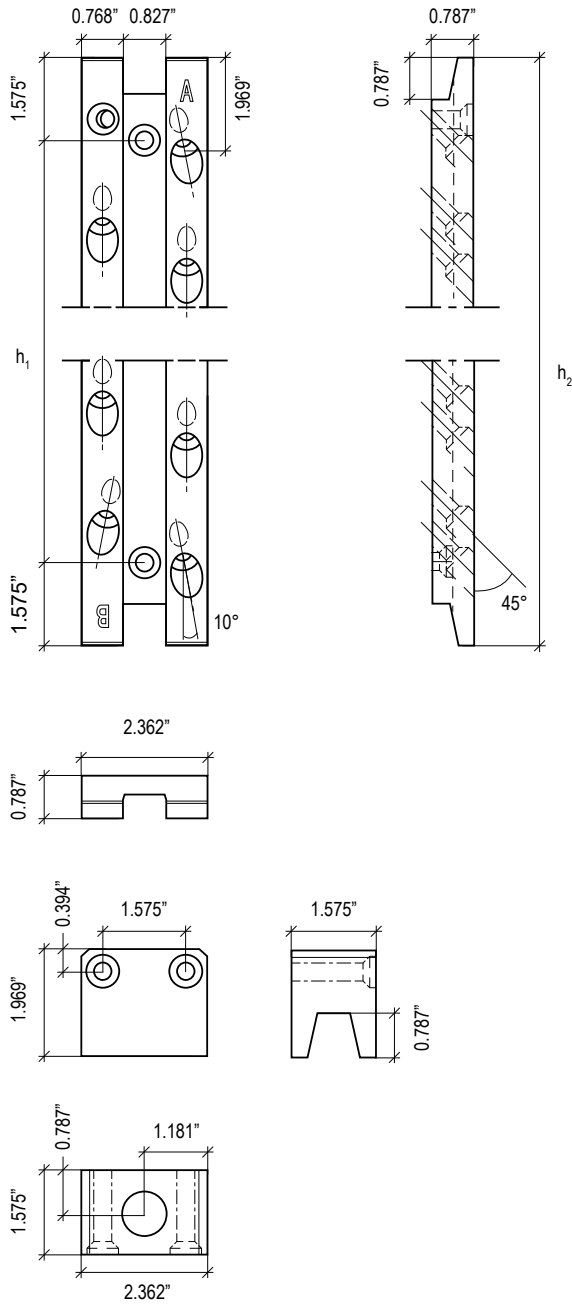

MEGANT 100 SERIES

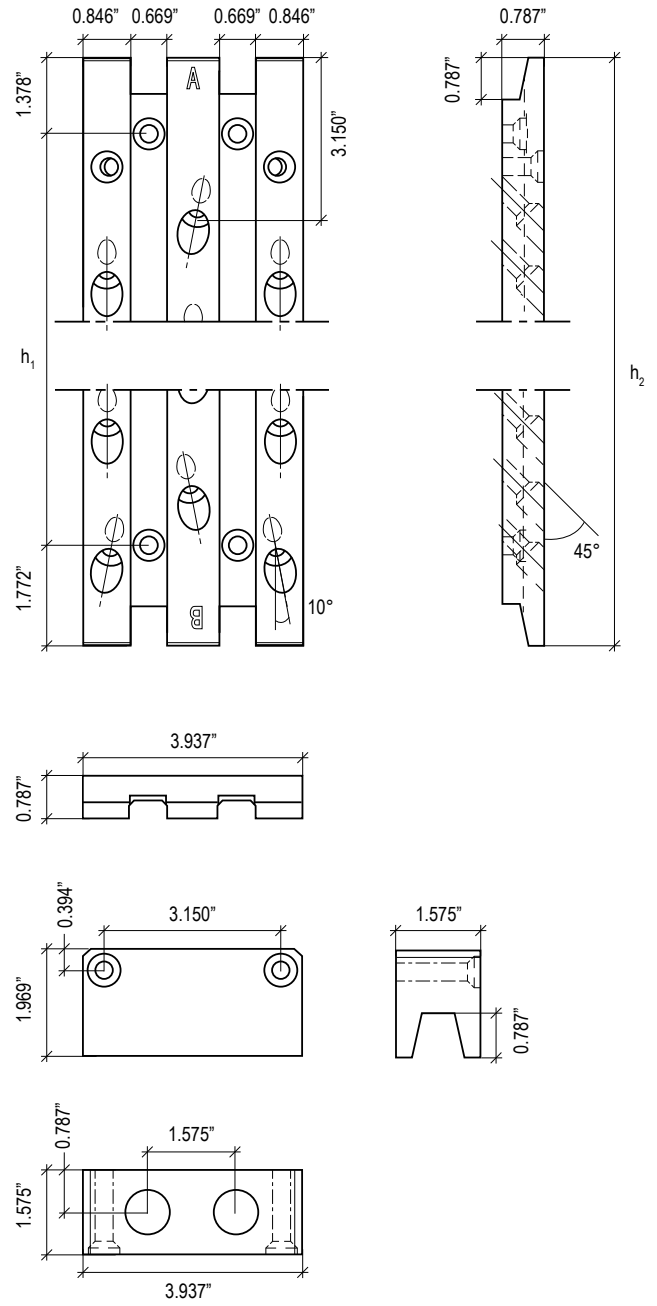

Model	h_1	h_2
	in.	
MEGANT 310 x 60	6.693	9.843
MEGANT 430 x 60	11.417	14.567
MEGANT 550 x 60	16.142	19.291

Model	h_1	h_2
	in.	
MEGANT 310 x 100	6.693	9.843
MEGANT 430 x 100	11.417	14.567
MEGANT 550 x 100	16.142	19.291

MEGANT 150 SERIES

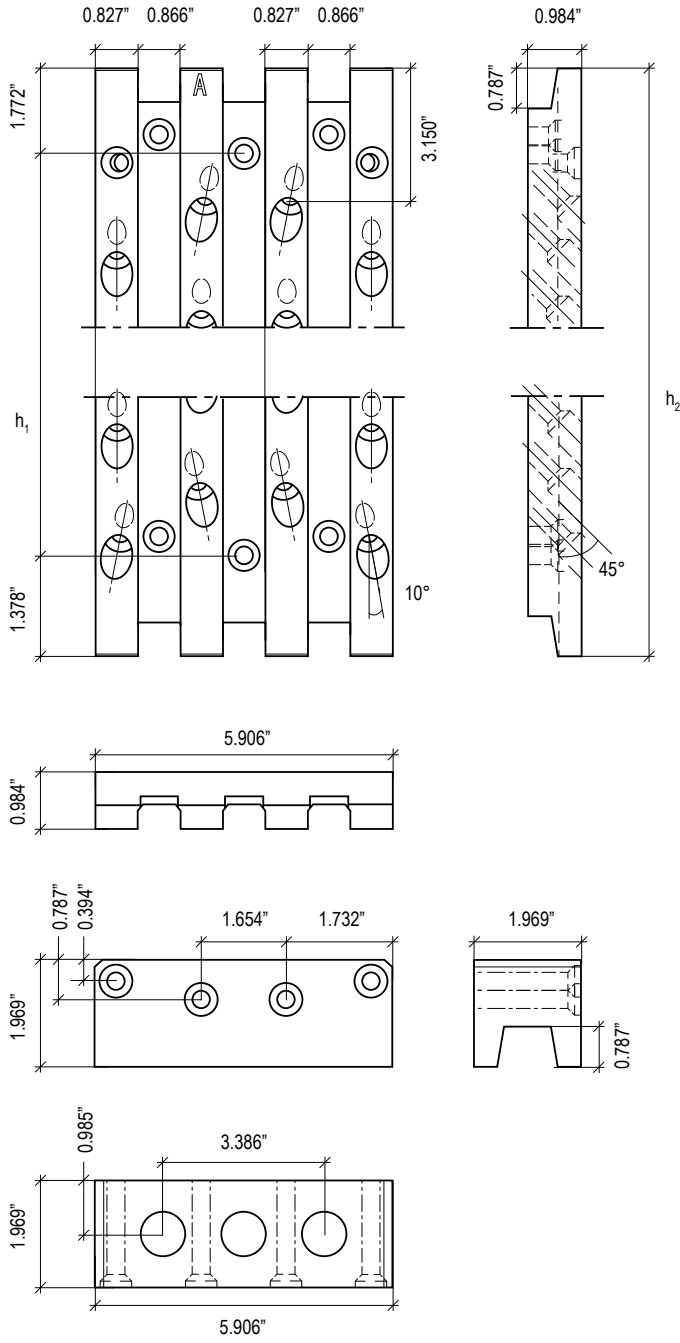

Model	h_1	h_2
	in.	
MEGANT 310 x 150	6.693	9.843
MEGANT 430 x 150	11.417	14.567
MEGANT 550 x 150	16.142	19.291
MEGANT 730 x 150	23.228	26.378

MTC Solutions provides sustainable, high-quality mass timber connection solutions to a rapidly evolving and thriving industry. We drive innovation through certified research and development, while contributing to the education of young talent and experienced professionals in the technology used in sustainable design.





MTC
SOLUTIONS

info@mtcsolutions.com

1.866.899.4090

mtcsolutions.com

